

INSTALLATION AND OPERATING MANUAL

Oil Fired Floorstanding Heaters

Two Stage, Low Nox Cabinet Heater

WARNINGS

Reznor equipment must be installed and maintained in accordance with the relevant provisions of the Gas Safety (Installations and Use) Regulations 1998 for gas fired products.

Due account should also be taken of any obligations arising from the Health and Safety at Works Act 1974 or relevant codes of practice.

In addition the installation must be carried out in accordance with the current IEE wiring regulations (BS 7671), BS 6896 (Industrial & Commercial) and any other relevant British Standards and Codes of Practice by a qualified installer. All external wiring MUST comply with the current IEE wiring regulations.

Reznor® is a registered trademark of Nortek Global HVAC, LLC.

Any reference made to Laws, Standards, Directives, Codes of Practice or other recommendations governing the application and installation of heating appliances and which may be referred to in Brochures, Specifications, Quotations, and Installation, Operation and Maintenance manuals is done so for information and guidance purposes only and should only be considered valid at the time of the publication. The Manufacturer cannot be held responsible from any matters arising from the revision to or introduction of new Laws, Standards, Directives, Codes of Practice or other recommendations.

Bio fuel statement - All our oil fired heater products are configured for use on both Class D light distillate fuel oil.

As a result of recent changes made to European legislation regarding the specification of class D heating oil to allow for the inclusion of 7% FAME (Fatty Acid Methyl Ester) i.e. bio fuel and effective from early 2011, all oil fired air heater products and installations maybe affected.

From April 2011 all our oil fired cabinet heaters will be fitted with Riello burners which are bio fuel compatible for blends up to 10%.

Please note that the use of bio fuels may give rise to a number of installation issues, to both new and existing plant which could affect the warranty of the burner. We recommend that you familiarise yourself with current information from both the burner manufacturer Riello and OFTEC.

Important notice to installers

Installers should satisfy themselves that the oil pipework installation is carried out in accordance with all current legislation, Codes of Practice and recommendations .

1.	Installation Requirements	6
	1.1 Compliance notices	6
	1.2 Certificates of conformity	7
	1.3 General product information	7
	1.5 Delivery and pre-installation checks	8
	1.6 Warranty	8
	1.7 Health and Safety	9
	1.8 Location / Positioning	9
	1.9 Fuel supply - general	10
	1.9.1 Fuel	10
	1.9.2 Storage tank	11
	1.9.3 Single pipe system (gravity feed)	11
	1.9.4 Two pipe system	11
	1.9.5 Pressurised ring main system	12
	1.9.6 Pipe work and fittings	12
	1.10 Electrical supply	15
	1.11 Air supply	15
	1.11.1 Heaters installed within the heated space	15
	1.11.1.1 Natural Ventilation Openings to the Heated Space	16
	1.11.1.2 Mechanical Ventilation to the Heated Space	16
	1.11.2. Heaters Installed within a Plant Room or Enclosure	16
	1.11.2.1 Natural Ventilation Openings to Plant Rooms	17
	1.11.2.2 Natural Ventilation Openings to Enclosures	17
	1.11.2.3 Mechanical Ventilation to a Plant Room or Enclosure	17
	1.12 Air distribution system	18
	1.13 Flue system	18
	1.14 Dimensions	22
	1.15 Technical Details	26
2.	Installation	28
	2.1 Packaging/siting	28
	2.3 Minimum clearances	28
	2.4 Assembly	28
	2.5 Flue Installation	28
	2.6 Oil Installation/connection	29
	2.7 Electrical Installation/connection	29
	2.8 Air Distribution Installation	29
	2.9 Warm Air Registers	30
	2.10 Heater Control Installation	30
3.	Commissioning	48
	3.1 Commissioning - Pretest	48
	3.2 Commissioning - Ignition	49
	3.3 Commissioning - air delivery system	50
	3.4 Commissioning - hand over	50

4.0	Servicing	51
	4.1 Planned Servicing	51
	4.2 Servicing Procedure - Major Component Parts	51
	4.2.1 Flue.....	51
	4.2.2 Main Fan Motor.....	52
	4.2.3 Main Fan.....	52
	4.2.4 Pulleys.....	52
	4.2.5 Fan Belts.....	53
	4.2.6 Heat Exchanger.....	53
	4.2.7 Electrical Supply.....	53
	4.2.8 Oil Supply	53
	4.2.9 Burner	54
	4.2.10 Air Delivery System.....	54
	4.2.11 Report.....	54
	4.3 Service Re-commissioning	54
5	Parts Lists	55
6.	Fault Finding Guide	60
7.	Replacement Parts	63
	7.1 Burner.....	63
	7.2 Controller.....	63
	7.3 Electrode Assembly.....	63
	7.4 Nozzle.....	64
	7.5 Photocell.....	64
	7.6 Oil Pump.....	64
	7.7 Contactor/Overload.....	65
	7.8 MCB	65
	7.9 Fan/Limit Stat Assembly.....	65
	7.10 Fan Belts	66
	7.11 Blower Motor	66
	7.12 Fan Blower	66
8.	User Instructions	67
	8.1 Commissioning and hand over.....	67
	8.2 Servicing	67
	8.3 Start Up Procedure.....	67
	8.4 Stop procedure.....	67
	8.5 Shut down procedure	68
	8.6 Ventilation only	68
	8.7 Lockout situations	68

Introduction.

Welcome to the Oil Fired Cabinet Heater Range. Local regulations may vary in the country of use and it is the installers responsibility to ensure that such regulations are satisfied

All installation, assembly, commissioning and service procedures must be carried out by suitable qualified competent persons to the statutory regulations in the country of use.

When installing, commissioning and servicing is undertaken on these heaters due care and attention is required to ensure that working at height regulations are adhered to at the mounting heights specified.

All Dimensions shown are in **mm** unless



PLEASE READ this document prior to installation and use. The safety of this heater is guaranteed only by the correct usage in accordance with these instructions, therefore it is recommended that they are retained for future reference.

The manufacturer reserves the right to alter specifications without prior notice.

1. Installation Requirements.

1.1 Compliance notices

The Oil Fired Cabinet Heater range detailed herewith are manufactured within a strictly controlled quality environment within the parameters of ISO 9001.

These instructions are only valid if the following country code is on the appliance GB. IE. If this code is not present on the appliance, it is necessary to refer to the technical instructions which will provide the necessary information concerning the modification of then appliance to the conditions of use for the country.

The Oil Fired Cabinet Heater range have been tested and assessed for compliance with the following European Directives.

- Machinery Directive: (2006/42/EC)
- Low Voltage Directive: (2006/95/EC)
- Electromagnetic Compatibility Directive: (2004/108/EC)
- Product Liability Directive: (85/374/EEC)

The manufacturer has taken reasonable and practical steps to ensure that all Oil Fired Cabinet Heaters are safe and without risk when properly used. These heaters should therefore only be used in the manner and purpose for which they were intended, and in accordance with the recommendations detailed herewith.

The Oil Fired Cabinet Heater range has been designed, manufactured, assembled, inspected, and tested, with safety and quality in mind, there are certain basic precautions which the installer and user should be aware of, and they are strongly advised to read the appropriate sections of the information pack accompanying the heater, prior to installation or use.

The manufacturer supports all new products being supplied to their customers with a comprehensive information pack; this clearly defines mandatory instructions for the safe installation, use, and maintenance, of the appliance(s).

Where proprietary items are incorporated into any Oil Fired Cabinet Heaters, detailed information and instructions are also provided as part of the information pack.

It is the responsibility of the installer, owner, user, or hirer of Oil Fired Cabinet Heaters to ensure that they are familiar with the appropriate information/manuals supplied by the manufacturer and the safety instructions. In addition, operators must be suitably trained in the use of the appliance so as to ensure its continued safe and efficient use.

The manufacturer has a commitment to continuous improvement and therefore reserve the right to amend or change the specification of Cabinet Heaters subject to compliance with the appropriate European, national and local regulations

Contained within the text of the manual, the words '**Caution**' and '**Warning**' are used to highlight certain points.



Caution is used when failure to follow or implement the instruction(s) can lead to premature failure or damage to the heater or its component parts.



Warning is used when failure to heed or implement the instruction(s) can lead to not only component damage, but also to a hazardous situation being created where there is a risk of personal injury.

The Oil Fired Cabinet Heater range conform to the following harmonised standards:

BS EN 292-1

Safety of Machinery - Basic Concepts, General Principles for Design Basic terminology, methodology BS EN 292-2

BS EN 292-2

Safety of Machinery - Basic Concepts, General Principles for Design Technical Principles and Specifications

BS EN 60204-1

Safety of Machinery - Electrical Equipment for Machines Specification for General Requirements

BS EN 60335-1

Safety of Household and Similar Electrical Appliances General Requirements

BS EN 55014

Limits and methods of measurement of radio disturbance characteristics of electrical motor-operated and thermal appliances for household and similar purposes, electrical tools and similar electric apparatus

BS EN 50165

Electrical Equipment of non-electric heating appliances for household and similar purposes, safety requirements

1.2 Certificates of conformity

Certificates of conformity are available from the manufacturer, address details are shown on the back page.

1.3 General product information

The Oil Fired Cabinet Heater models have an output range from approximately **32.0 kW** to **381kW**, and are available in a configuration that will allow for down flow, horizontal, or floor mounting.

The units can suit either ducted applications, or be used as free blowing units, but each heater must be connected to its own individual open flue.

Each heater is fitted with a forced draught burner which has been test fired and pre-set prior to despatch. The safety functions of the burner are by way of a fully sequential control box fitted to the burner.



Neither asbestos nor soft soldered joints are used in the construction or manufacture of The Oil Fired Cabinet Heater range. The materials selected for use can withstand the mechanical, chemical, and thermal stresses which they will be subject to during foreseen normal use when installed in accordance with the manufacturers recommendations.

1.4 General requirements



CAUTION

Ensure the fuel supply is in accordance with the manufacturer's recommendations and is as stated on the appliance data plate.



CAUTION

Installation, commissioning, and servicing must only be carried out by appropriately qualified and competent persons.



WARNING

Unauthorised modifications to the appliance, or departure from the manufacturers guidance on intended use, or, installation contrary to the manufacturers recommendations may constitute a hazard.



To ignore the warning and caution notices, and to ignore the advice from the manufacturer on installation, commissioning, servicing, or use, will jeopardise any applicable warranty, moreover, such a situation could also compromise the safe and efficient running of the appliance itself, and thereby constitute a hazard.

The installation of the appliance must meet all the relevant European, national, and local criteria.

Prior to installation the following points should be considered;

- The position of the heater for the optimum efficient distribution and circulation of warm air.
- The position of the heater relative to the route of the flue
- The position of the heater relative to the supply of fuel
- The position of the heater relative to the electrical services, and if appropriate, any additional controls.
- The position of the heater relative to the supply of fresh air
- The height if applicable at which the heater is to be mounted and potential stratification /circulation problems.
- The position of the heater relative to service and maintenance requirements



The heater must not be installed within an area where the conditions are unsuitable, e.g. where the atmosphere is highly corrosive, has a high degree of salinity, or where high wind velocities may affect burner operation. Suitable protection should be provided for the appliance when it is located in a position where it may be susceptible to external mechanical damage from; for example, fork lift trucks, overhead cranes etc.

1.5 Delivery and pre-installation checks.

The heater is supplied wrapped in heavy duty protective polythene. On receipt of the heater, the following checks should be carried out;

- The model is as per order.
- That it is undamaged.
- That it is suitable for the fuel supply.
- That it is suitable for the electrical supply

If any of these points are not satisfied then contact should be made with the suppliers sales office as soon as possible by telephoning the number shown on the rear page. In the case of claims for damage, this must be signed for as damaged and reported in writing within 24 hours of delivery, in order to comply with insurance criteria.

1.6 Warranty

The heater is supplied with a 1 year parts and labour warranty and a further year on all parts excluding consumables.

In addition to this there is a 10 year time related warranty on the combustion chamber.

The warranty commences from the date of dispatch from the manufacturer, and is subject to the terms detailed within the Manufactures 'conditions of business'.



Note (i) The warranty may be invalidated if ...

- The installation is not in accordance with the general requirements of this manual.
- The flue arrangement and air supply for the heater are not in accordance with the manufacturers recommendations, codes of practice, or similar standards.
- Air flow through the heater is not in accordance with the manufacturers technical specifications.
- Internal wiring on the heater has been tampered with or unauthorised service or repairs undertaken.
- The main electrical supply input to the heater has been interrupted during the heating mode.
- The heater has been subject to and affected by the ingress of water in any form.
- The heater is not operated at the rating(s) laid down in the manufacturers technical specifications.
- The heater has not been operated or used within the normal scope of its intended application.
- The manufacturer's recommended minimum service requirements have not been complied with



Note (ii) All warranty claims must contain the following info to enable processing to take place

- Heater model
- Heater serial number
- Order reference/date of order, together with full installation details (name and address)
- Details or symptoms of fault
- Installers name and address.

Faulty parts must be returned to the supplier, the address of which is provided at the rear of this manual.

Any such parts will undergo inspection to verify the claim. Replacement parts supplied prior to this may be charged, and a credit supplied upon subsequent validation of the warranty claim.

Consumable items are specifically not included within the scope of the warranty.



Note (iii) Notification is required immediately a fault is suspected.

The manufacturer will not accept responsibility for any additional damage that has been caused, expense incurred, or consequential loss resulting from any failure of the heater(s).

1.7 Health and Safety



The Oil Fired Cabinet Heater range must be installed in accordance with the current OFTEC regulations for oil fired products. Due account should also be taken of any obligations arising from the Health and Safety at Works Act 1974 or relevant codes of practice. In addition the installation must be carried out in accordance with the current IEE wiring regulations (BS 7671), BS 6896: (Industrial & Commercial) and any other relevant British Standards and Codes of Practice by a qualified installer. Isolate all electrical supplies to the heater & controller before proceeding.

For your own safety we recommend the use of safety boots and leather faced gloves when handling sharp or heavy items. The use of protective eye wear is also recommended.



Before using this appliance:

- Check that the voltage indicated on the type plate corresponds to the mains supply voltage.
- Ensure that the heater has been securely fastened in its final mountain position.



UNDER NO CIRCUMSTANCES should any item be placed on or above any part of the heater, whether the heater is being used or not. This appliance must be earthed.

1.8 Location / Positioning



All of the basic criteria must be satisfied prior to commencing installation and commissioning, additionally, the Oil Fired Cabinet Heater must be positioned and installed so as to comply with all the relevant standards and guide lines (see section 1.1), as well as meeting national and local fire regulations and insurance criteria, especially if it is proposed that the heater is to be installed within a special risk area (e.g. proximity to where petrol engined vehicles are stored or parked, where cellulose spraying takes place, where woodworking machinery is operated, etc.).

Indirect heaters must not be located in hazardous areas, however, it is permissible for the heater to supply air to such areas.

The heater must not be installed within an environment where there is a high concentration of chlorides, fluorides, salts, or other aggressive or volatile chemicals/compounds. Nor should the heater be positioned where the burner could be adversely affected by high winds or draughts.

The location chosen for the heater must allow for the fitting of an effective flue system.

The location must also allow for adequate clearance for the air supply, return air circulation, oil supply and electrical supply, whilst also providing good and safe working access. The heater must be installed on a flat and level surface made from non-combustible material, which is sufficiently robust to withstand the weight of the heater and any ancillary equipment. Any combustible material adjacent to the heater or flue system must be so placed or shielded so that its surface temperature does not exceed 65°C.

In areas where it is proposed that more than one heater is to be installed, a general scheme of circulation should be drawn up and maintained, thereby offering the best heat distribution

All Oil Fired Cabinet Heaters are fitted with a pressure relief facility, this is incorporated into the design of the flue gas exit duct.

Care should therefore be taken in siting service connections and controls well away from the pressure relief vent.



Under no circumstances must the pressure relief be restricted, blocked, or have the free exit of exhaust gas impaired or re-directed.

1.9 Fuel supply - general

The Oil Fired Cabinet Heater range are all manufactured and pre-set for use with 35 second gas oil delivered to the burner via a suitable piped system from the oil storage tank.



Galvanised or plastic pipe work and fittings must not be used. (See BS 5410 Part 1 1997)

The constraints of the application will, to a large extent, determine whether it is preferable to use a single pipe gravity feed system, or whether the two pipe pumped system is more appropriate.

Where more than one appliance is to share a common supply it will be necessary to use a pressurised ring main system.

All pipe work must be constructed and installed so that it does not permit the ingress of air.

The construction, size, and position of the oil storage tank must take account of the current regulations, as well as suiting the requirements of the installation.

Please refer to pages 9 and 10 for additional information.



On pumped systems always check that the pump is correctly set up prior to running, and always ensure that valves are open allowing a free flow of oil through the system.

1.9.1 Fuel

In order to promote trouble free operating it is necessary that the oil within the storage tank and oil line does not fall below the cold filter plugging point (cfpp), in this country and with class D fuel (also referred to as gas oil). The critical temperature is -4°C for this summer grade.

The cfpp critical temperature for the winter grade is -12°C. If summer grade fuel is stored for winter use in areas prone to severe frosts and low temperatures it will be necessary to insulate or even heat the supply tank and pipe work.



The fuel supplier should be contacted prior to installation so that any requirements concerning delivery, transport, storage and use can be addressed before work commences.

The inlet pump pressure must not exceed a maximum of 0.4 bar, this is because beyond this point gas is liberated from the oil.

1.9.2 Storage tank

An externally painted steel storage tank to BS 799 part 5 1987 or a medium density polyethylene oil tank OFTEC certified to OFS T-100 may be used. Local, national, European and fire regulations must also be complied with and must include:

- A fuel level gauge (not made from glass) a vent pipe with a diameter greater than that of the filler and featuring a weatherproof termination.
- A sludge valve.
- An outlet valve situated at the opposite end of the tank to the sludge valve.
- A filler pipe connection situated at the opposite end to the outlet valve.

The size of the storage tank must take account of the estimated consumption and any quantity price breaks offered by the oil supplier.

It is preferable to install the tank outside, however, if this is not practicable and the tank has to be installed indoors advice must be sought about its siting, especially so far as fire regulations are concerned.

If a separate fire resistant chamber cannot be provided for indoor installations, a catchment pit with a capacity 10% greater than that of the storage tank must be provided

Storage tanks can if necessary be sited on a roof, but this is subject to special regulations as well as local authority approval and compliance with fire regulations, reference to BS 5410 part 2 1978 & part 1 1997 is strongly suggested.

It is advisable to leave the tank unpainted on the inside, but to paint the outside with a proprietary grade of anti-corrosive paint.



A galvanised or open topped tank is strictly not allowed.

All oil storage tanks require a bund

The Control of Pollution Regulation (Oil Storage) 2001 should be consulted prior to installation.

1.9.3 Single pipe system (gravity feed)

For installations where the oil tank is 200mm or more above the level of the fuel pump the principle of gravity feed may be used.

The draw off point for the supply to the burner must not be positioned any lower than 100mm above the bottom of the tank.

Where a return valve is fitted this must be tamper proof to prevent inadvertent operation.



If the valve is closed when the pump is running the oil pressure can be increased sufficiently so as to cause damage to the seals within the pump.

The return oil should preferably be discharged through an elbow onto a tank plate situated within the tank, this should be positioned so as not to introduce air or air bubbles into the draw off pipe.

1.9.4 Two pipe system

This is used where the oil storage tank is lower than the pump.

Access for the fuel feed to the burner should be via a suitable tapping made in the top of the tank, and the fuel feed pipe should extend to not less than 100mm above the bottom of the tank.

A non return valve with a metal to metal seat should be fitted, especially if the return pipe work is terminated at a level above the draw off tube. The non- return valve must be removable for service and maintenance purposes, and the return pipe from the pump must therefore be extended down into the tank to the same level as the suction pipe.

The presence of a tamper proof isolating valve fitted within the return pipe is only required if there is a risk that oil will siphon out of the tank if the return pipe is disconnected at the pump during maintenance or servicing and if the non return valve has been omitted.

1.9.5 Pressurised ring main system

This system is used to supply a number of units from a common storage tank. A booster pump is used to provide the pressure to push the oil around the ring main and back to the tank.

Pressure reducing valves should be fitted on the delivery pipe to each heater to ensure that the pressure at the burner pump is less than 6 psi.



The internal by-pass plug must be removed from the burner pump when used in a pressurised ring main application.

1.9.6 Pipe work and fittings



Galvanised or plastic pipe work and fittings must not be used. (See BS 5410 Part 1 1997)



All joints must be sealed properly, if necessary using PTFE tape or other approved sealing media. The pipe work must be effectively sealed so as to prevent the ingress of air.



It is advisable to check all pipe work prior to installation to ensure that there is no loose debris or scale present.

Black iron pipes can be hammered to assist in the removal of these contaminants.



The oil feed to each heater must be fitted with a fire check valve and isolating valve.



The fire check valve must be operated by way of a fusible link positioned so that it is above the burner.

Typical arrangement of oil storage tank and single pipe system

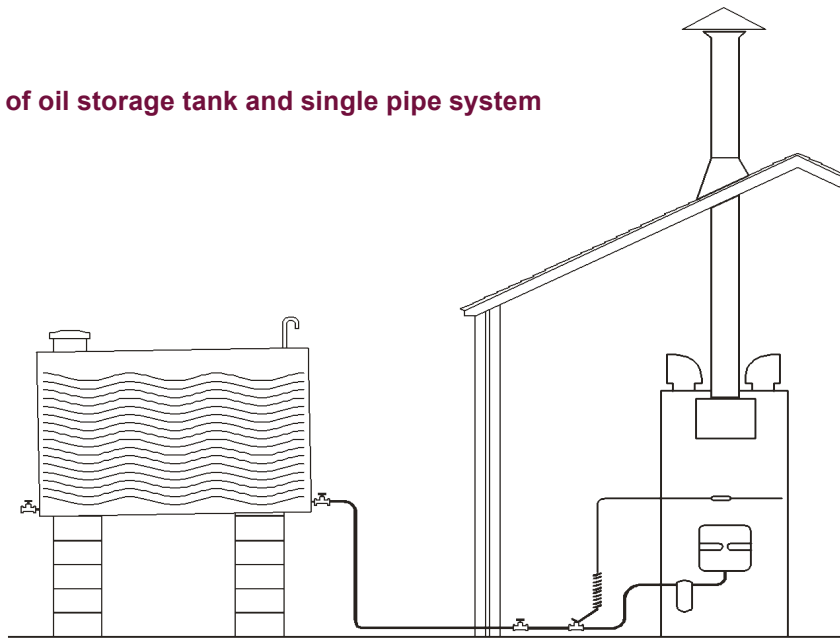

Pressurised oil feed system

- 1 GATE VALVE
- 2 IN-LINE FILTER
- 3 PUMP
- 4 RELIEF VALVE
- 5 PRESSURE GAUGE
- 6 PRESSURE REDUCING VALVE
- 7 RETURN TO TANK

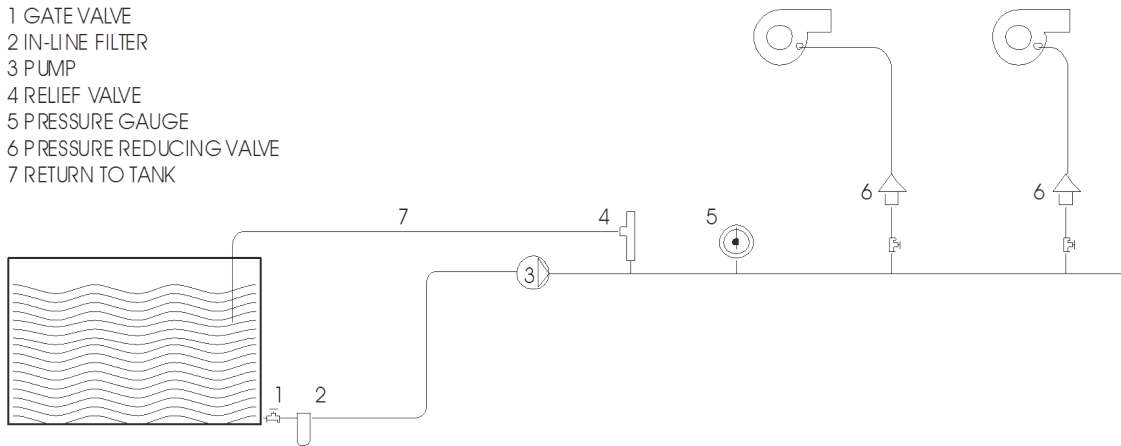

Burner oil pump details for heater models 30 - 180 oil lines

WARNING:

Before starting the burner make sure that the return pipeline is not clogged;
Any obstruction would cause the pump seals to break

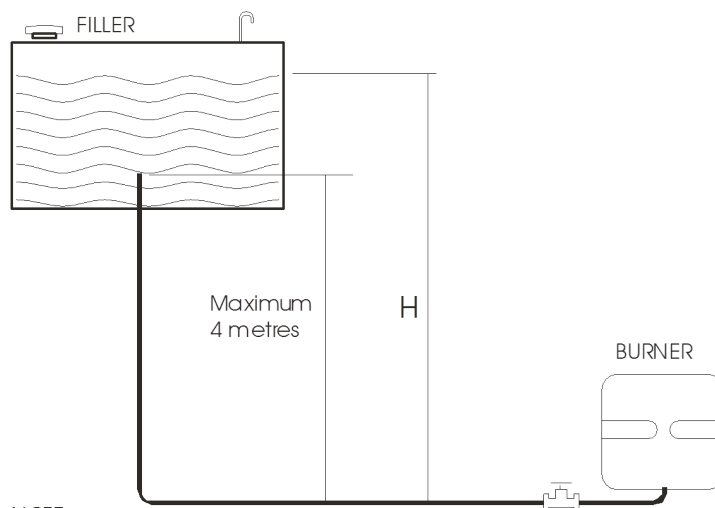

NOTE:

All burners are despatched suitable for gravity feed installations

H(m)	L metres	
	8mm I.D	10mm I.D
0.5	10.0	20.0
1.0	20.0	40.0
1.5	40.0	80.0
2.0	60.0	100.0

Burner oil pump details for heater models 30 - 180 oil lines

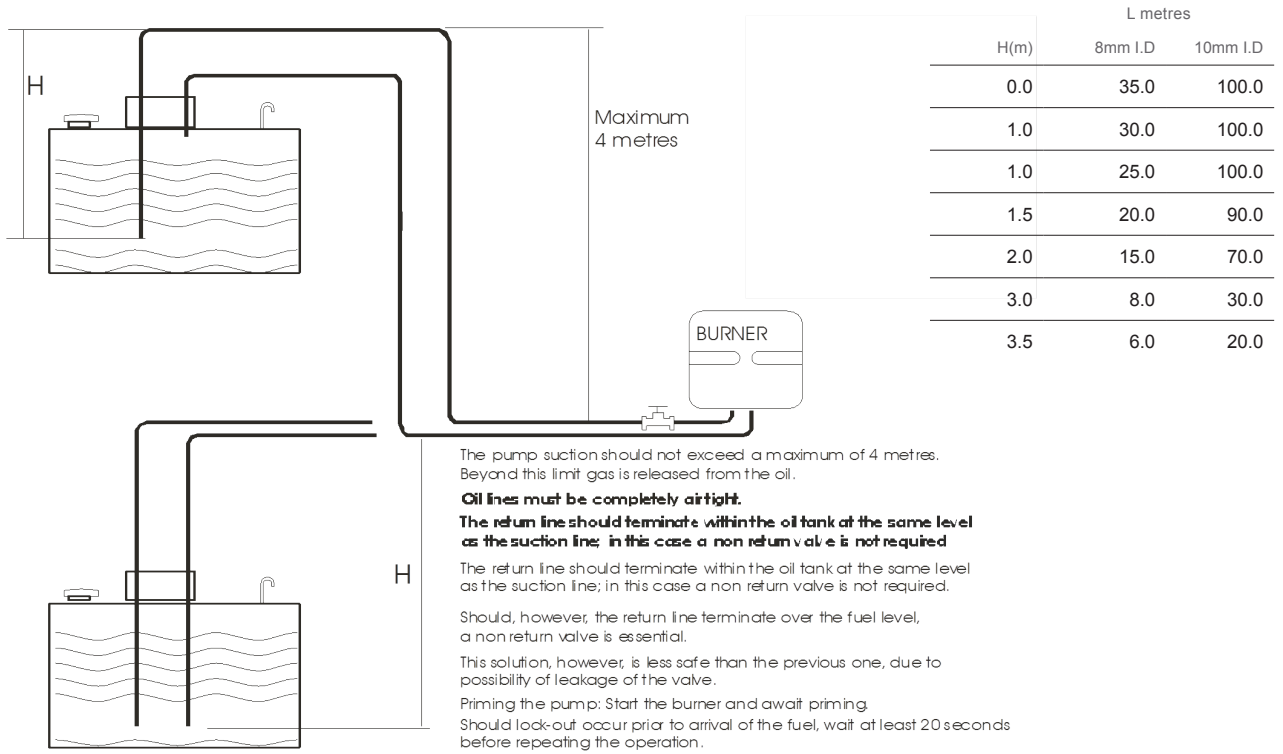

Burner oil pump details 205-375 gravity feed from bottom of tank

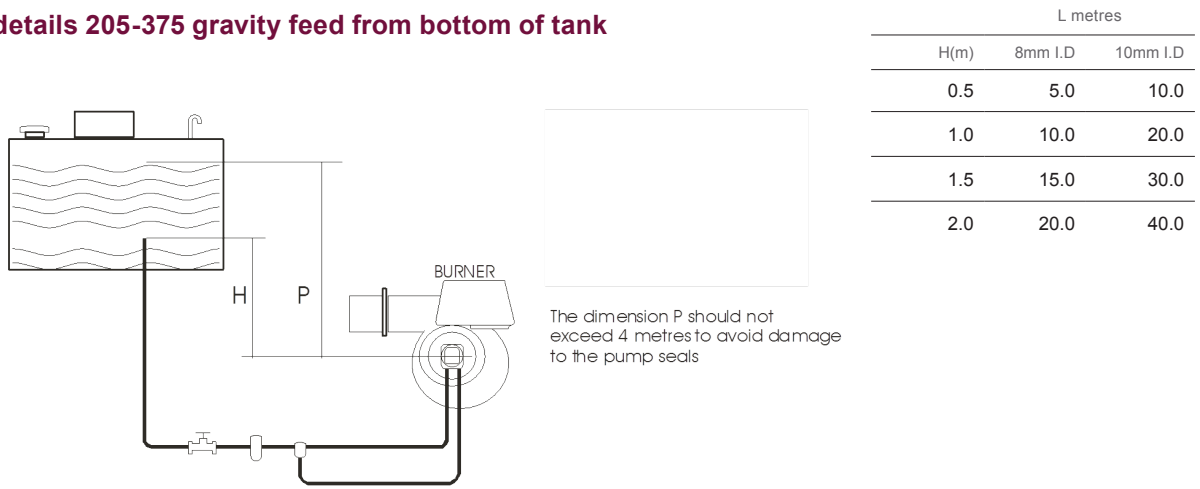

Burner oil pump details 205 - 375 suction feed

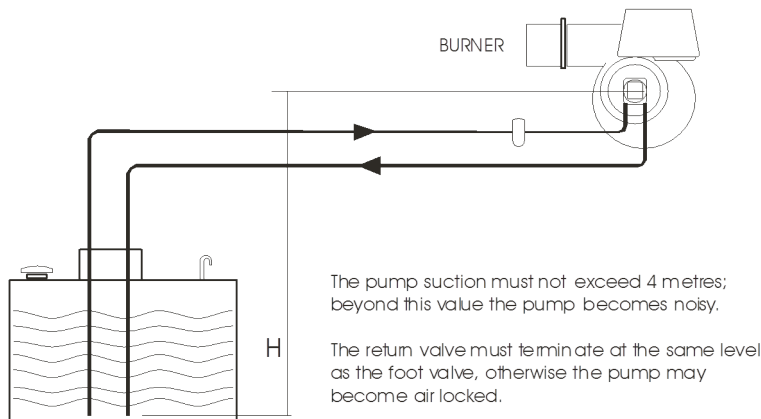

1.10 Electrical supply

Wiring external to the cabinet heater must be installed in accordance with any local, national, and European regulations, as well as meeting the appropriate requirements of IEE regulations.

 The means of connection to the main electrical supply must allow for complete electrical isolation of the heater, furthermore, in the case of a unit wired for a three phase supply, the supply should only be used to serve the heater itself and no other plant or equipment. The position of the isolation switch must be such that it is adjacent to the heater and easily accessible at all times. In addition, the isolator itself must have a contact separation of not less than 3mm.(As per BS5991 clause 20.2).

The Control fuse ratings are detailed on the appliance data plate.

 Ensure that the electric and oil supplies are turned off before any electrical work is carried out on the heater.

 Ensure that wiring cannot make contact with any surfaces liable to be subject to high temperatures or where the insulation of the wiring could be impaired as a result of such contact.

 All cabinet heaters must be earthed.

 The main electrical supply must not be switched off or disconnected as a method for stopping the heater, the exception to this is in an emergency, or during servicing, when the heat exchanger has been allowed to cool sufficiently to prevent any damage from occurring. Claims for damage will not be considered if they have resulted from incorrect wiring or the incorrect use of the heater.

1.11 Air supply

Consideration must be given to the provision of air for the purposes of combustion and ventilation of the heated space, plant room or enclosure where heaters are to be installed.

 It is strongly recommended that BS6230 is referred to for further information concerning ventilation requirements

Where mechanical ventilation is used it is a requirement that the inlet is of the mechanical type, and the outlet is either mechanical or natural.

1.11.1 Heaters installed within the heated space.

Where heaters are installed within the space to be heated (i.e. not a plant room or enclosure) then:

Combustion air or heater related ventilation air will not be required if -

The design air change rate of the heated space is 0.5 air changes per hour or greater

OR

The design air change rate may be satisfied by natural infiltration or by mechanical ventilation

Combustion and General ventilation will be required if -

The design air change rate of the heated space is less than 0.5 air changes per hour

OR

Where the heated space has an air change rate of less than 0.5 air changes per hour then it will be necessary to provide either natural ventilation openings to the heated space (section 1.11.1.1. refers) or the mechanical ventilation of the heated space (section 1.11.1.2. refers)

1.11.1.1 Natural Ventilation Openings to the Heated Space.

If the heated space design air change rate is less than 0.5 air changes per hour then provision for low level natural ventilation openings will only be necessary.

The minimum free area of the low level natural ventilation opening shall be:

- 2cm² for each kW of rated heat input

The low level natural ventilation opening should be situated on an external wall and be within 1000 mm of floor level.

The following table provides specific data for each heater model as

Model	Minimum Free Area of ventilation opening	
	High Level cm ²	Low Level cm ²
30	None	64
40	None	97
60	None	127
85	None	193
120	None	257
135	None	291
180	None	386
205	None	460
235	None	515
300	None	623
375	None	847

1.11.1.2 Mechanical Ventilation to the Heated Space.

In the event that the heated space has a design air change of less than 0.5 air changes per hour and that installer prefers to mechanically ventilate the heated space rather than provide ventilation openings then:-

- The heated space needs to be mechanically ventilated so that the design air change is 0.5 air changes or greater.
- It is a requirement that the mechanical ventilation shall be of the 'input' type with either natural or mechanical extraction.
- Systems of mechanical extraction with a natural inlet shall not be used.

It is necessary to provide an automatic means to safely inhibit heater(s) operation should mechanical air supply fail for any reason.

1.11.2. Heaters Installed within a Plant Room or Enclosure.

A plant room means a room housing the heater plant and probably other items of building service plant and would generally have generous space for maintenance.

An enclosure is where the heater is installed within a compartment or confined area where space is limited.

Where heaters are installed within a plant room or enclosure then provision for both combustion air and air for general ventilation will be required by means of high and low level ventilation openings (sections 1.11.2.1 refers to plant room applications and sections 1.11.2.2 refers to enclosure applications).

Alternatively the plant room or enclosure may be mechanically ventilated (section 1.11.2.3 refers).

1.11.2.1 Natural Ventilation Openings to Plant Rooms

For plant room applications the minimum free area of ventilation opening shall be:

- At high level 2 cm² for each kW of rated heat input.
- At low level 4 cm² for each kW of rated heat input.

The high level ventilation opening should be sited on an external wall and positioned as high as is practical and always within the top 15% of the wall height.

The low level natural ventilation opening should be situated on an external wall and be within 1000 mm of floor level.

The table below provides specific data for each heater model as -

Model	Minimum Free Area of ventilation opening	
	High Level cm ²	Low Level cm ²
30	64	128
40	97	194
60	127	254
85	193	386
120	257	514
135	291	582
180	386	722
205	460	920
235	515	1030
300	623	1246
375	847	1694

1.11.2.2 Natural Ventilation Openings to Enclosures

For enclosure applications the minimum free area of ventilation opening shall be:

- At high level 5 cm² for each kW of rated heat input.
- At low level 10 cm² for each kW of rated heat input.

The high level ventilation opening should be sited on an external wall and positioned as high as is practical and always within the top 15% of the wall height

The low level natural ventilation opening should be situated on an external wall and be within 1000 mm of floor level.

The table in the next column provides specific data for each heater model as:-

Model	Minimum Free Area of ventilation opening	
	High Level cm ²	Low Level cm ²
30	159	318
40	244	488
60	317	634
85	483	966
120	643	1286
135	726	1452
180	965	1930
205	1152	2304
235	1287	2574
300	1558	3116
375	2118	4236

1.11.2.3 Mechanical Ventilation to a Plant Room or Enclosure.

In the event that the installer prefers to mechanically ventilate the plant room or enclosure rather than provide ventilation openings then:-

- The plant room or enclosure needs to be mechanically ventilated at the rate of 4.14 m³/h of fresh air per kW or rated heat input.
- It is a requirement that the mechanical ventilation shall be of the 'input' type with either natural or mechanical extraction. Where mechanical extraction is selected then the extraction rate should be 5%-10% less than the input rate.
- Systems of mechanical extraction with a natural inlet shall not be used
- It is necessary to provide an automatic means to safely inhibit heater(s) operation should mechanical air supply fail for any reason

The table to the right provides specific data for each heater model as -

Model	Mechanical Ventilation Rate for Plant Room or Enclosure
	M ³ /h
30	139
40	206
60	274
85	409
120	567
135	717
180	822
205	987
235	1131
300	1410
375	1830

1.12 Air distribution system

All materials used within the construction of the delivery and return air ducts must not represent a fire hazard and should be made from thermally inert materials. The selection of materials must take account of the environment into which the heater and its air delivery system is expected to work, it must also take account of the stresses and loadings placed upon it during its normal working life. Where interjoist spaces are used to route ducting these must be lined with fire resistant insulation material.

In installations where forced recirculation is a feature, a full and unobstructed return air path to the heater(s) must be provided, with return air grilles connected by ducting directly to the return air inlet on the heater.

The limit for recirculation should not be greater than 85% re-circulated air to 15% fresh air.

Where the heater is installed within a compartment or plant room the return air and discharge air arrangement must be such that the air circulation fan does not interfere with the operation of the flue. The return air intake and warm air outlet should therefore be fully ducted to and from the heater, respectively, within the compartment or plant room.

If the inlet air is ducted to the outside, then the lowest edge of the inlet air duct must be at least 500mm above the outside floor or ground level, it must also be fitted with an access point(s) to allow for cleaning and servicing to occur.

The openings in the structure of the plant room, through which the ductwork passes must be of fire resistant material and constructed to prevent the likelihood of any fire from spreading.

In ducted applications the ductwork must be designed so as to give a static pressure within the limits stated in section 1.15 of this manual. It should be noted that if the static pressure is too high, nuisance shut-down will occur when the heater goes out on the overheat limit thermostat, if the static pressure is too low, then damage can be caused to the fan motor.

Warm air outlets on ducted applications must be such that they cannot be closed or become blocked, which again would lead to an increase in static pressure and nuisance shut-down. The outlets must not be sited so that warm air can be discharged onto combustible materials, if necessary, guard rails should be used to ensure that effected areas are kept clear.

Return air intakes must not be located so that potentially harmful or hazardous contaminated air can be drawn into the system.

1.13 Flue system.



It is essential that the products of combustion are flued to the outside of the building. Each heater must have its own separate flue, with a flue diameter of not less than is detailed in section 1.15 within this manual.

The minimum vertical length of flue must not be less than 3m. The flue should rise vertically, and the number of bends should be kept to a minimum.

Flue pipes below a height of 2m should be guarded against the possibility of being accidentally touched when hot by personnel



It is strongly advised that BS 5854; 1980, and BS 5440; parts 1 and 2, are used as consultative documents when considering flue requirements.

Care should be taken to ensure that the flue terminal is not situated in a high-pressure area, the proximity of buildings and other obstacles which will influence this must be taken into account, preferably at the design stage. See pages 15 & 16

Provision must be made for the disconnection of the flue for inspection and service requirements, and it is strongly advised that where bends are fitted inspection covers are included.

The materials from which the flue is constructed must be non-combustible, resistant to internal and external corrosion, and be capable of withstanding the stresses and loadings associated with normal use.

When designing the flue system the prevention of the formation and entrapment of condensation must be a key consideration.

Twin wall or insulated systems are recommended, as they tend to inhibit the formation of condensates.

Where condensation is unavoidable traps should be included to encourage the condensates to flow freely to a point from which they may be released, preferably into a gully. The condensate pipe from the flue to the disposal point must be made from corrosion resistant pipe of not less than the internal diameter of the drain pipe.

If the flue passes through a wall, ceiling, or roof made from combustible material then it has to be sleeved so as to provide a minimum of a 25mm void between the exterior of the flue and the internal wall of the sleeve. The maximum permitted temperature of any adjacent combustible material is 65°C. The position of the flue and its terminal should be such that it does not impair the combustion process.

It should terminate in an exposed position so as to allow the escape and dissipation of flue gases without risk of their re-entering the property through windows, ventilation ports, etc. The flue should extend to at least 1m above the height of any object within 3.5m of the terminal. Flue terminals should be fitted on all flues, the terminal must be of the approved type, and have outlet grilles on all sides giving a total free area of at least double that of the flue.



It is imperative that the flue should be properly sealed where it passes through the roof, this can best be achieved by using the approved method of roof flashing plate and cravat.



It should be noted that claims made under warranty and attributed to the ingress of water may not be considered especially if an approved method of sealing has not been used, or if the design of the flue has not made provision for possible condensation problems.

Flat roof with parapet

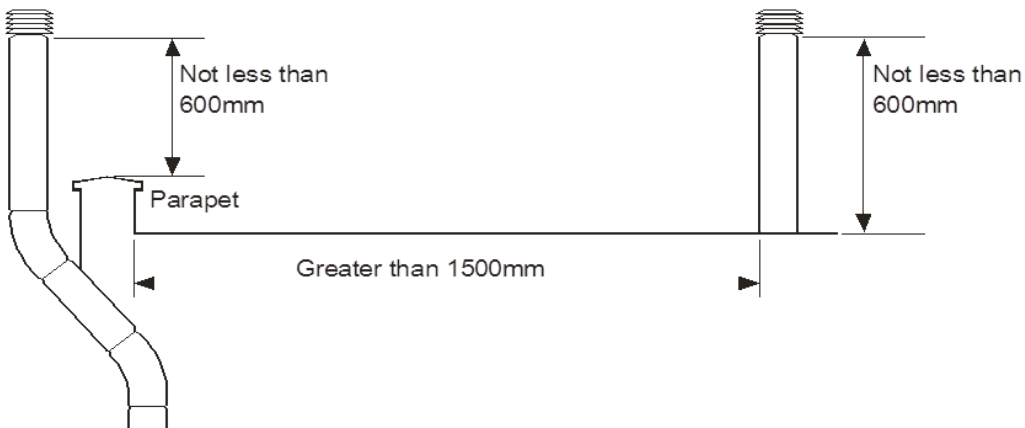

Flat roof envelope method

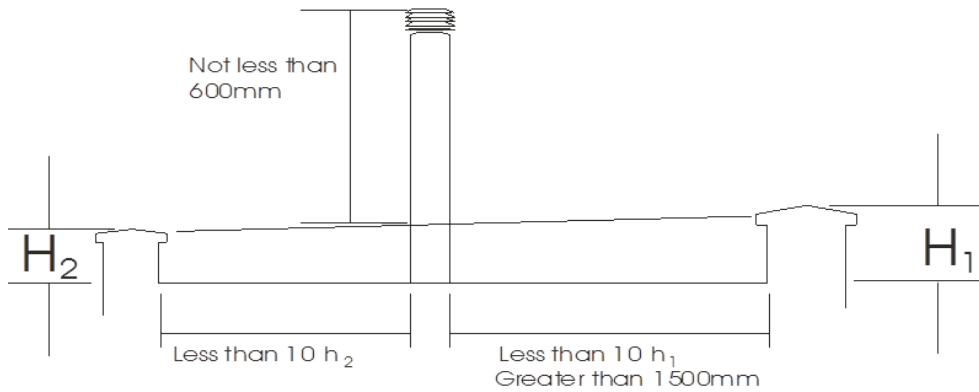

Flat roof where the flue height is more than 10 Heights (H) away from all structures

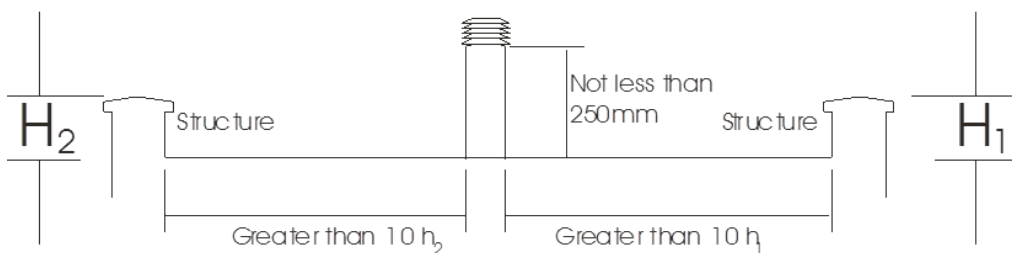

Flat roof with flue close to parapet

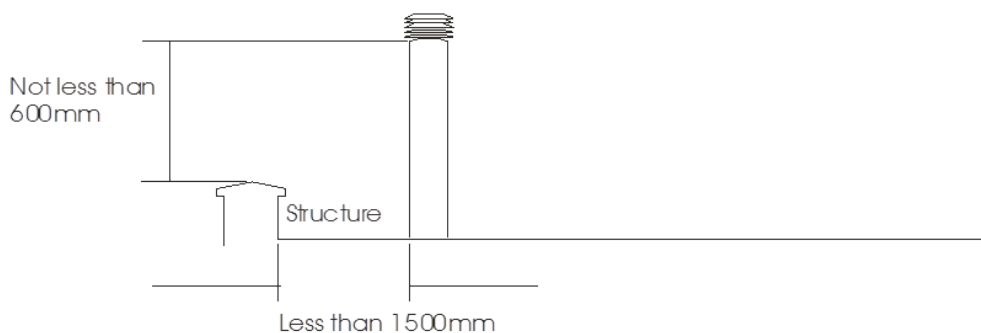

Flat roof with no parapet

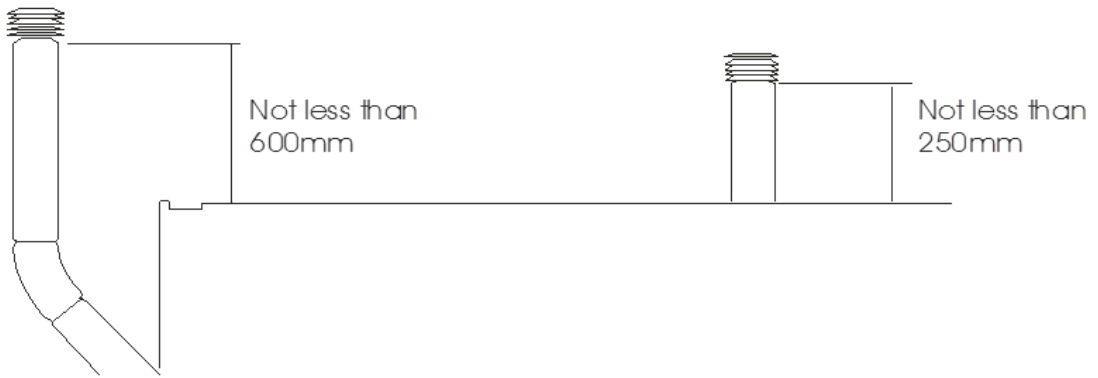

Flat roof with structure close to flue outlet

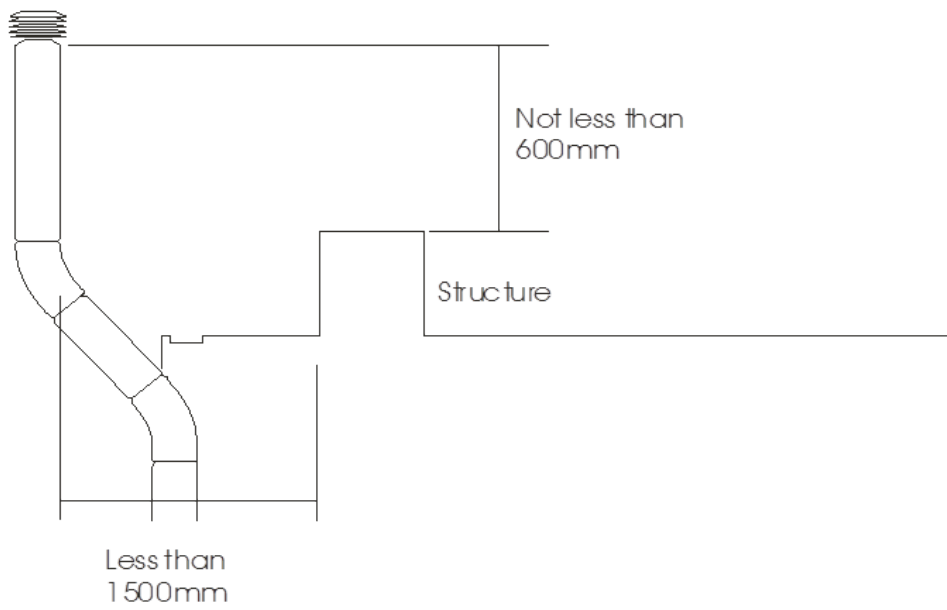

Pitched roof not greater than 45°

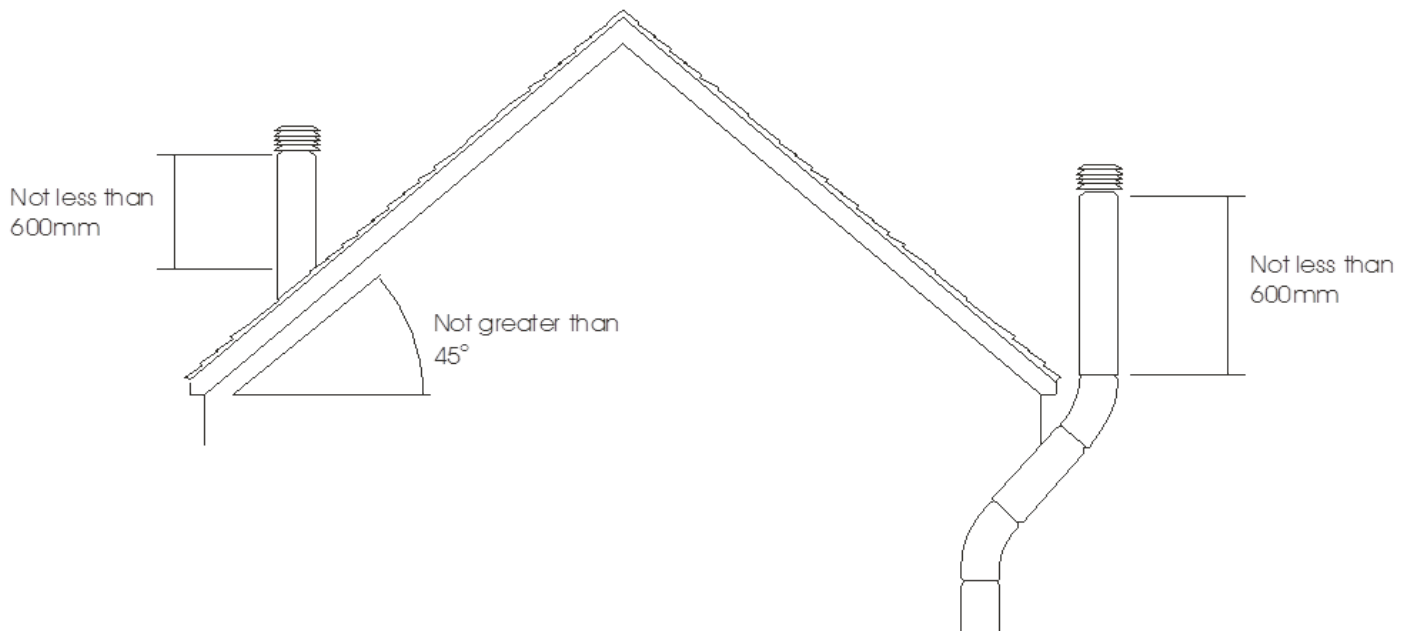

1.14 Dimensions

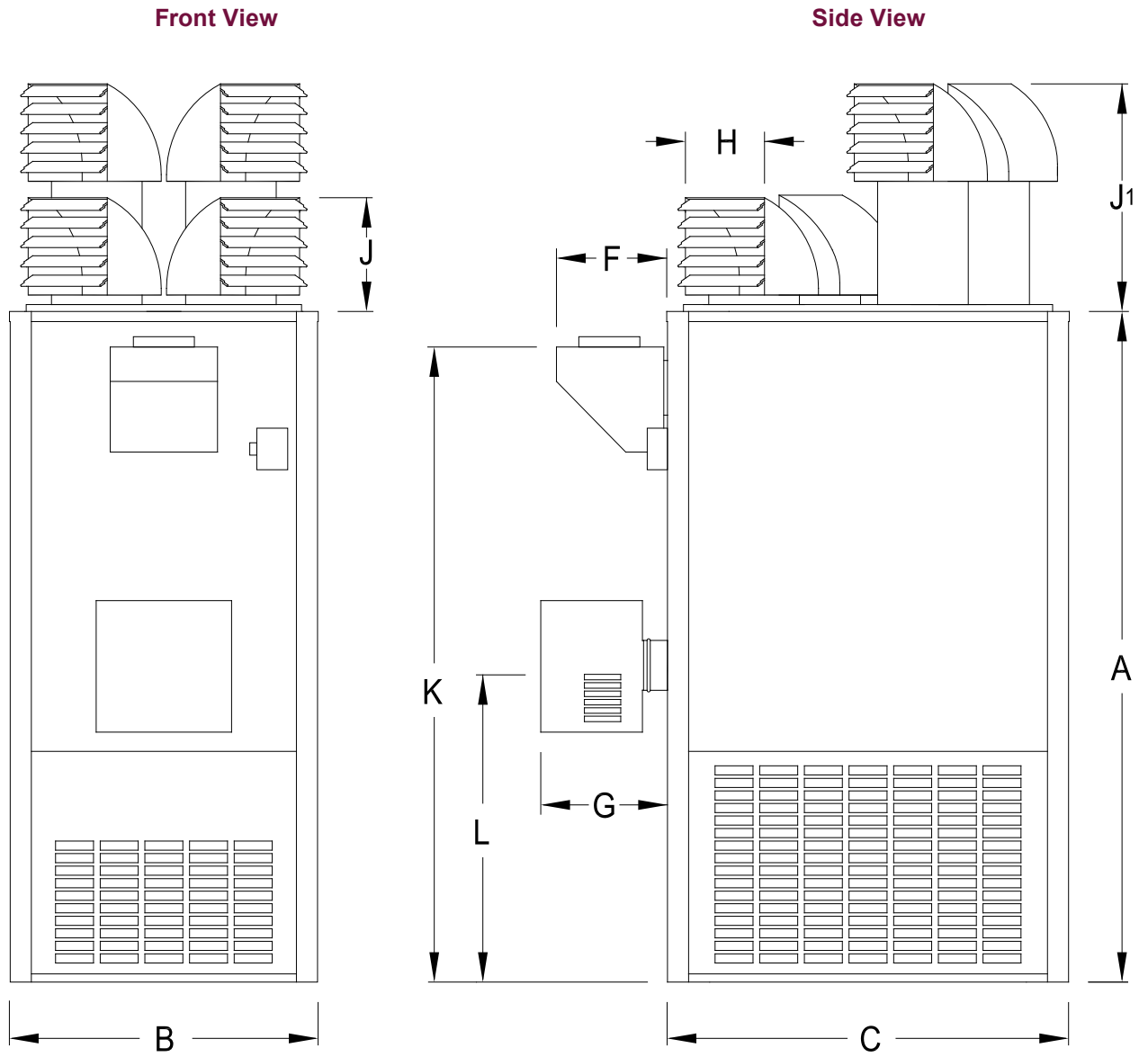

Top View - Nozzle Outlet (also showing spigot Ø)

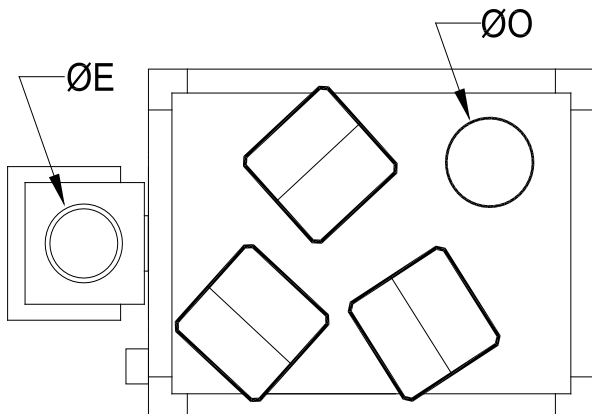

Top View - Duct Outlet

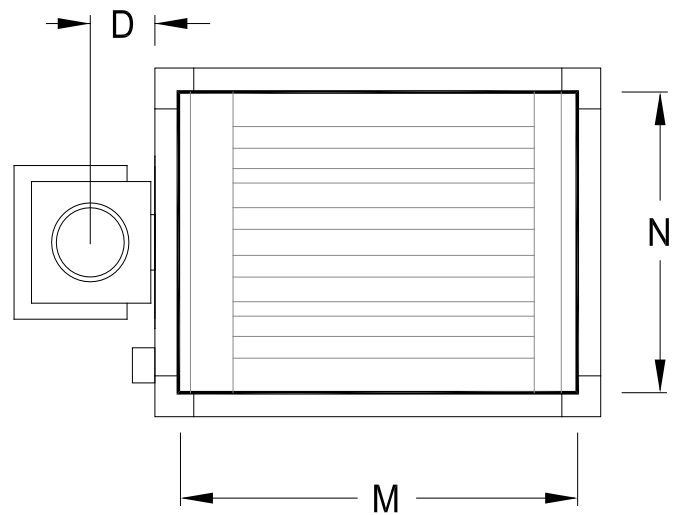

Dimensions for Vertical Cabinet Heaters (all dims in mm)

Model	30	40	60	85	120	135	180	205	235	300	375
A Unit height	1650	1650	1900	1900	2025	2025	2120	2120	2110	2110	2667
B Unit width	660	660	660	660	790	790	1000	1000	1100	1100	1244
C Unit depth	662	662	925	925	1085	1085	1282	1282	1550	1550	1550
D Flue outlet ctr	95	95	170	170	170	170	213	213	195	195	203
E Flue Spigot Ø	125	125	150	175	175	175	200	200	225	225	250
F Stack Box depth	250	250	320	320	327	327	394	394	380	380	355
G Burner depth	197	197	205	205	223	223	225	225	508	508	508
H Nozzle outlet width	280	280	280	280	305	305	355	355	406	406	474
J Nozzle height Std	240	300	300	330	360	360	410	410	460	460	613
J1 Nozzle height Ext	n/a	n/a	n/a	660	720	720	815	815	915	915	1115
K Stack Box height	1500	1500	1778	1778	1865	1865	1980	1980	1965	1965	2610
L Burner ctr/l height	835	835	984	984	971	971	1068	1068	1054	1054	1372
M Outlet Spigot depth	570	570	770	770	944	944	1120	1120	1452	1452	1365
N Outlet Spigot width	570	570	634	634	711	711	890	890	1002	1002	1086
O Nozzles Spigot Ø	240 (2)	240 (2)	240 (2)	240 (3)	280 (3)	280 (4)	320 (4)	320 (4)	370 (4)	370 (4)	370 (4)

Side Inlet Spigot (L/H or R/H)

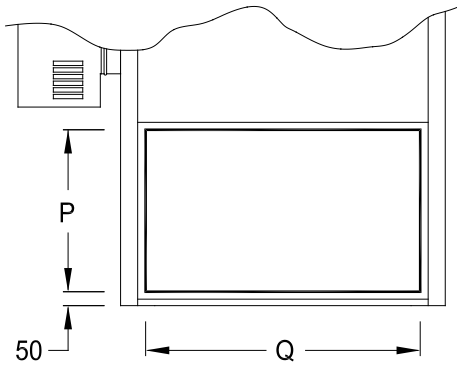

Rear Inlet Spigot

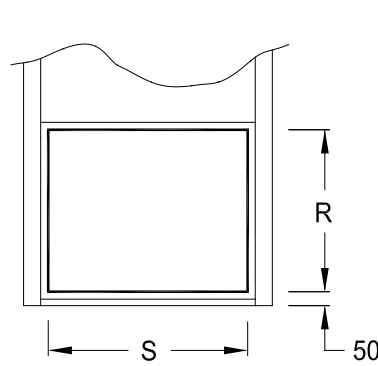

Side Inlet inc Filter box (L/H or R/H)

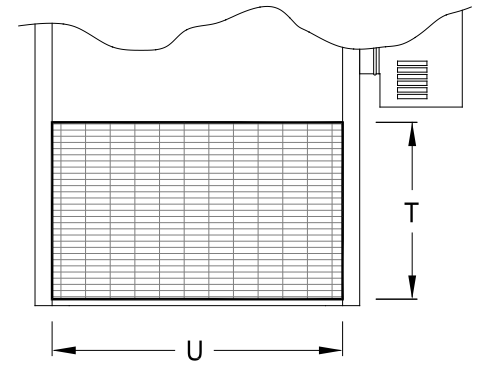

Dimensions of Return Air Spigots (all dims in mm)

Model	30	40	60	85	120	135	180	205	235	300	375
P Side height	348	348	427	427	642	642	691	391	654	654	796
Q Side width	522	522	702	702	904	904	1077	1077	1145	1145	1150
R Rear height	445	445	550	550	642	642	896	896	654	354	n/a
S Rear width	620	620	520	520	687	687	691	691	935	935	n/a
T Filterbox height	420	420	600	600	702	702	765	765	720	720	860
U Filterbox width	660	660	800	800	990	990	1165	1165	1245	1245	1530
V Filterbox depth	300	300	300	300	300	300	300	300	450	450	450

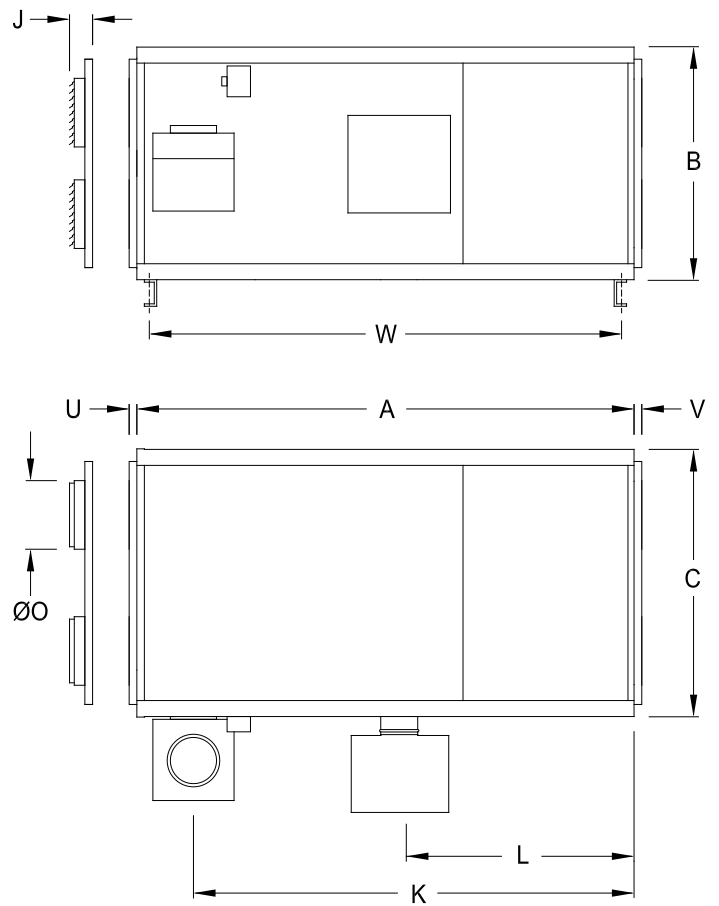
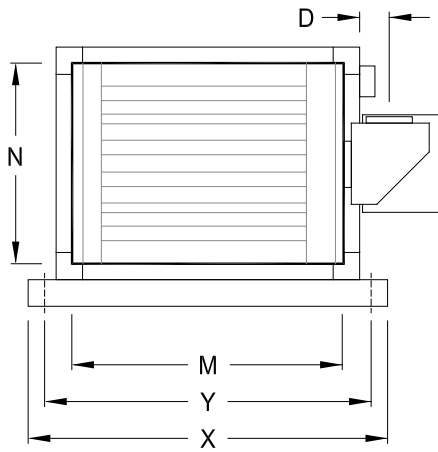

Dimensions for Horizontal Cabinet Heaters (all dims in mm)

Model		85	135	205	300	375
A	Unit length	1865	1960	2057	2076	2667
B	Unit height	660	790	1000	1100	1244
C	Unit width	925	1085	1282	1550	1550
D	Flue outlet ctr to front	170	170	213	195	203
J	Outlet nozzle width	160	280	366	320	320
K	Flue outlet ctr/l to end	1660	1761	1858	1823	2426
L	Burner ctr/l to end	984	971	1068	1054	1372
M	Outlet Spigot width	770	944	1120	1452	1365
N	Outlet Spigot height	634	711	890	1002	1086
U	Outlet Flange depth	30	30	30	30	30
V	Inlet Flange depth	50	50	50	50	50
W	Feet centres length	1806	1895	1992	2020	2612
X	Feet width	1157	1365	1565	1826	1826
Y	Feet centres width	1081	1289	1489	1750	1750

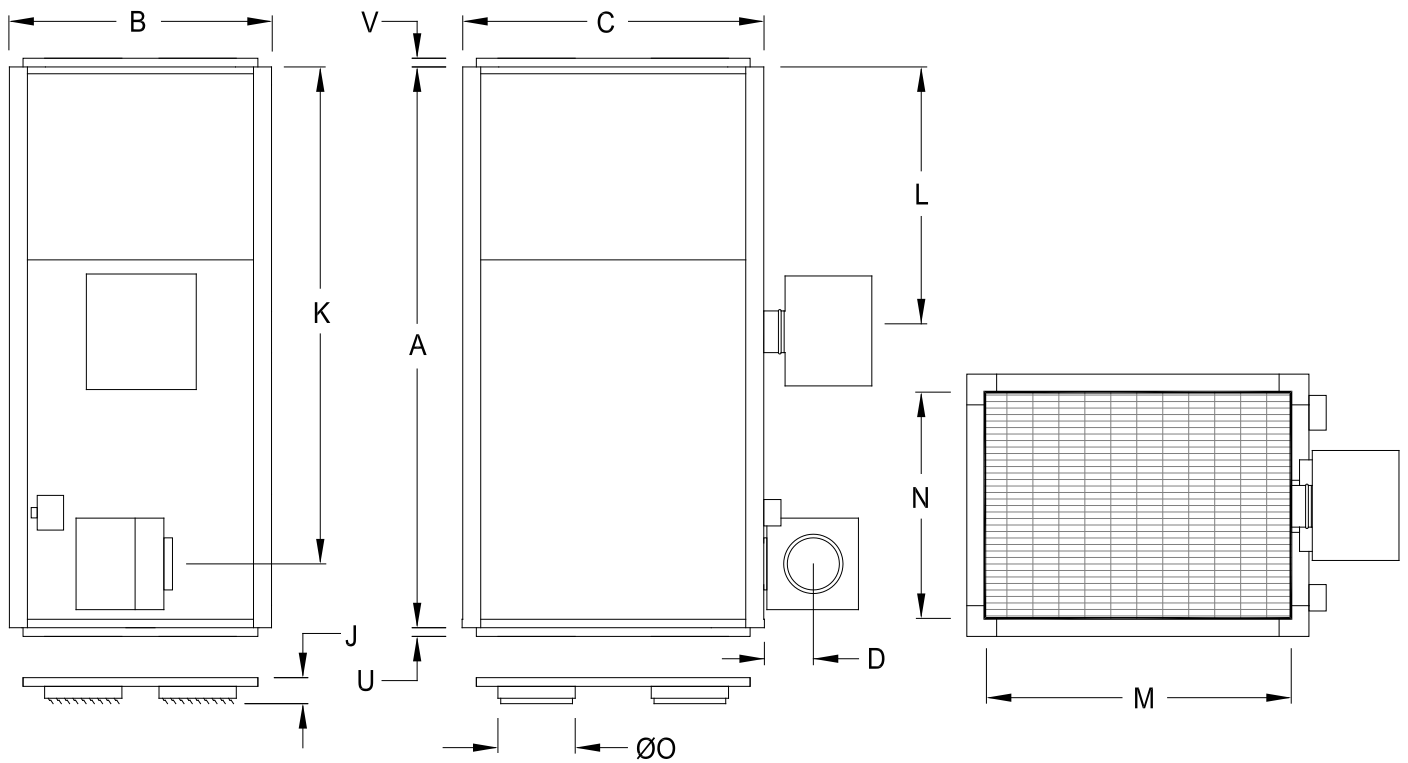

Dimensions for Downturn Cabinet Heaters (all dims in mm)

Model	85	135	205	300	375	
A	Unit height	1865	1960	2057	2076	2667
B	Unit width	660	790	1000	1100	1244
C	Unit depth	925	1085	1282	1550	1550
D	Flue outlet ctr to front	170	170	213	195	203
J	Outlet nozzle height	160	280	366	320	320
K	Flue outlet ctr/l to top	1660	1761	1858	1823	2426
L	Burner ctr/l to top	984	971	1068	1054	1372
M	Outlet Spigot width	770	944	1120	1452	1365
N	Outlet Spigot height	634	711	890	1002	1086
U	Outlet Flange depth	30	30	30	30	30
V	Inlet Flange depth	50	50	50	50	50

1.15 Technical Details

		30	40	60	85	120	135	180	205	235	300	375	
Heat Output (max)	High Fire	kW/hr	31.79	41.01	58.80	75.18	104.66	127.68	182.93	205.11	242.63	265.52	381.00
		hr	108,471.98	139,931.93	200,633.93	256,524.81	357,114.74	435,662.24	624,183.07	699,864.37	827,887.92	905,991.85	1,300,025.96
	Low Fire	kW/hr	26.12	31.49	44.98	56.27	76.70	95.66	93.81	118.31	175.78	184.82	
		hr	89,125.14	107,448.34	153,478.13	192,001.21	261,711.26	326,405.47	320,093.01	403,690.48	599,786.26	630,632.02	
Heat Input (gross)	High Fire	kW/hr	36.95	51.64	67.29	93.93	119.83	148.68	210.04	238.91	283.72	339.62	483.50
		hr	126,078.63	176,202.99	229,603.01	320,502.46	408,876.93	507,317.22	716,686.23	815,194.76	968,092.82	1,158,831.54	1,649,770.48
	Low Fire	kW/hr	29.68	38.73	50.22	68.35	85.79	108.42	103.21	131.57	199.46	227.82	227.82
		hr	101,272.36	132,152.25	171,357.75	233,219.88	292,727.63	369,944.40	352,167.14	448,935.47	680,585.77	777,354.11	777,354.11
Heat Input (nett)	High Fire	kW/hr	34.66	48.45	63.13	88.13	112.43	139.76	197.06	224.15	266.19	318.64	435.58
		hr	118,264.83	165,318.26	215,408.50	300,712.04	383,627.08	476,880.91	672,396.63	764,831.55	908,277.98	1,087,244.81	1,486,260.65
	Low Fire	kW/hr	27.84	36.34	47.12	64.12	80.49	101.72	96.83	123.44	187.14	213.75	213.75
		hr	94,994.02	123,997.23	160,780.11	218,786.52	274,643.28	347,083.05	330,397.67	421,194.76	638,548.19	729,345.27	729,345.27
Nett Efficiency	High Fire	%	91.72	90.22	93.14	90.94	93.09	91.36	92.83	91.52	91.15	88.83	90.10
	Low Fire	%	93.80	92.37	95.16	93.55	95.29	94.04	96.88	95.84	93.93	92.17	92.17
Fuel Consumption 35s	High Fire	Imp gall/hr	0.93	1.29	1.73	2.36	3.08	3.37	5.33	6.17	7.40	8.51	11.89
		litre/hr	3.51	4.90	6.54	8.92	11.65	12.74	20.18	23.35	28.03	32.23	45.00
	Low Fire	Imp gall/hr	0.74	0.97	1.26	1.71	2.29	2.86	4.00	3.37	5.01	5.71	5.71
		litre/hr	2.82	3.68	4.76	6.49	8.65	10.81	15.14	12.74	18.95	21.62	21.62
Burner Pressure 35s	High Fire	Psi	204.00	232.00	245.00	247.00	237.00	237.00	175.00	181.00	290.00	290.00	170.00
		Bar	14.07	16.00	16.89	17.03	16.34	16.34	12.07	12.48	19.99	19.99	11.72
	Low Fire	Psi	130.00	130.00	130.00	130.00	130.00	130.00	175.00	181.00	130.00	130.00	170.00
		Bar	8.96	8.96	8.96	8.96	8.96	8.96	12.07	12.48	8.96	8.96	11.72
Fuel Consumption 28s	High Fire	Imp gall/hr	1.07			2.53							
		litre/hr	4.06			9.57							
	Low Fire	Imp gall/hr	0.86			2.13							
		litre/hr	3.24			8.08							
Burner Pressure 28s	High Fire	Psi	140			150.00							
		Bar	9.65			10.34							
	Low Fire	Psi	100			100.00							
		Bar	6.89			6.89							
Head Setting 0 flue resistance	High Fire	Number	1.50	3.50	0	5.00	0	0	0	7.50	4.00	1.00	1.00
	Low Fire	Number	1.50	3.50	0	5.00	0	0	0	7.50	4.00	1.00	1.00
Air setting 35s 0 flue resistance	High Fire	Number	4.00	3.20	3.00	3.00	1.50	2.00	6.00	5.50	80.00	150.00	150.00
	Low Fire	Number	0.40	0.60	0.50	1.00	0.125	0.25	0.20	0.30	30.00	33.00	33.00
Air setting 28s 0 flue resistance	High Fire		5			3.50							
	Low Fire					1.00							
Temp. Rise Through Heater	High Fire	°C	34.10	32.80	39.40	42.70	34.90	39.70	49.40	51.70	53.10	59.30	59.30
		°F	93.38	91.04	102.92	108.86	94.82	103.46	120.92	125.06	127.58	138.74	138.74
	Low Fire	°C	31.40	31.00	30.40	36.80	25.50	30.50	25.90	25.50	40.00	46.90	45.00
		°F	88.52	87.80	86.72	98.24	77.90	86.90	78.62	77.90	104.00	116.42	113.00
Burner Type	Riello	RG1RKD	RG1RKD	RG2D	RG2D	RG3D	RG4D	RG5D	RG5D	RL32	RL32	RL44	
Nozzle Size 35s		0.65/60°S	0.85/45°S	1.1/60°S	1.5x60°S	2.0x60°S	2.5x60°S	2.0x60°S + 2.0x60°S	2.5x60°S + 2.0x60°S	4.5x60°S	5.0x60°S	4.5x60°B+ 4.5x60°B	
Nozzle Size 28s		0.85/45°S			2.25x60°S								
Nozzle Discharge Velocity	m/sec	5.73	4.53	6.8	6.88	7.55	6.98	6.13	6.71	6.55	7.39	8.49	
	ft/min	1127.952758	891.7322848	1338.582679	1354.330711	1486.220475	1374.01575	1206.692915	1320.866144	1289.370081	1454.724412	1671.259845	
Air Throw (approx)	m	14	14	17.1	17.1	20.2	20.2	20.2	21.7	21.7	24.8	31.1	
	ft	45.93176	45.93176	56.102364	56.102364	66.272968	66.272968	66.272968	71.194228	71.194228	81.364832	102.034124	
Air Delivery (std)	m³/hr	2196	256	3708	5004	7740	9540	11196	12240	15552	17496	6.88	
	ft³/min	77,551.08	9,040.56	130,946.91	176,714.76	273,335.78	336,902.24	395,383.38	432,251.93	549,214.21	617,865.99	242.97	
Sound Level	dBA	76.5	76.5	76.7	76	77	77	78	78	78.2	80	81	
Seasonal Efficiency	Number%	72.3	72.1	72.6	72	75	74.6	78.3	75.1	72.4	72.1		

		30	40	60	85	120	135	180	205	235	300	375
Electrical Supply	Standard	230/1/50	230/1/51	230/1/52	230/1/53	415/3/50	415/3/51	415/3/52	415/3/53	415/3/54	415/3/55	415/3/50
Rated Input	kW	0.55	0.55	1.5	1.5	1.5	2.2	3	3	4	5.5	7.5
Fused Isolator Size	Amps	16	16	20	20	16	16	25	25	32	32	64
Running Current	Amps	5	6.2	9.3	10.7	6.8	7	7	7.4	9.8	11.1	24
Electrical Supply	Optional	N/A	N/A	415/3/50	415/3/50	230/1/50	230/1/50	N/A	N/A	N/A	N/A	N/A
Rated Input	kW	N/A	N/A	0.75	0.75	1.5	2.2	N/A	N/A	N/A	N/A	N/A
Fused Isolator Size	Amps	N/A	N/A	16	16	40	40	N/A	N/A	N/A	N/A	N/A
Running Current	Amps	N/A	N/A	2.2	2.2	12	14	N/A	N/A	N/A	N/A	N/A

Burner		BS1D	BS2D	BS3D	BS4D	RS35 Blu	RG1RKD	RG2D	RG3D	RG4D	RG5D	RL32	RL44	
Electrical Supply		230/1/50	230/1/51	230/1/52	230/1/53	230/1/50	230/1/50	230/1/50	230/1/50	230/1/50	230/1/50	230/1/50	230/1/50	
Motor Running Current	Amps	0.8	0.8	1.8	1.9	3.5	0.85	0.9	2	2	2.1	2.9	3	
Ignition Transformer	Primary	Voltage/ Amps	230/0.2	230/0.2	230/0.2	230/0.2	230/1					230/1.9	230/0.2	
Absorbed Electrical Power	Secondary	kV/mA	8/12	8/12	8/12	8/12	15/25	8/16	8/16	8/16	8/16	8/16	2x5/30	2x12/30
		kW	0.15	0.18	0.35	0.53	0.7	0.29	0.18	0.39	0.39	0.47	0.6	0.7

Doc/Ref	Title/Subject
BS 5410-1 & -2	Code of Practice for Oil firing
BS EN 292-1 & -2	Safety of Machinery
BS EN 60204-1	Safety of Machinery - Electrical
BS EN 60335-1	Safety of Electrical Appliances
BS EN 55014	Electromagnetic Compatibility
BS EN 50165	Safety of Electrical Equipment
BS 5854	Code of Practice - Flues/Flue Structures
BS 799-5	Oil Burning Equipment - oil tanks
OFTEC OFS T-10	Polyethylene oil storage tanks
BS 715	Metal Flue Pipes and Fittings
BS 5440-1	Specification/Installation of Flues
BS 5440-2	Ventilation Requirements Gas Appliances
BS779	Oil Burning Equipment - Burners
ISO 228/1	Pipe Threads Seals and Couplings

See also BS 2779 and BS 5380)

Model	Front	Rear	LHS	RHS
30 - 40	500	700	150	150
60 - 85	500	1000	150	150
120 - 135	600	1200	150	150
180	600	1500	150	150
205	900	1500	150	150
235 - 300	900	2000	400	400
375	900	2000	500	500

2. Installation.

It is strongly advised that the installer reads Section 1 of this manual prior to starting any installation work. It is a requirement that only qualified and competent personnel undertake installation, commissioning, and servicing.



Always ensure that the appropriate personal protective equipment is used.

2.1 Packaging/siting

The heater will usually be supplied wrapped in heavy gauge polythene, non assembled parts will be supplied separately.

Prior to installation, the assembly of the heater should be completed, it is advisable that this is undertaken in the area where the heater is scheduled to be sited.



It is strongly advised that when positioning the heater the lifting eyes are used, thereby reducing the risk of inadvertent damage being occasioned to the heater.

2.2 Flooring

The heater must be installed on a level non-combustible surface capable of supporting the weight of the heater and any ancillary equipment.

2.3 Minimum clearances

The following minimum clearances (in millimetres) are recommended when installing the heater.

2.4 Assembly

The following sub-assembly parts should be assembled to allow installation to continue.

(a) Vertical Nozzled Models - For free blowing applications it will be necessary to complete the final assembly before continuing with the installation. The bonnet top with nozzle spigots should be attached to the heater and secured. The nozzles should then be pushed home on the spigots and positioned to provide the desired airflow.

- Ensure louvres are adjusted outwards and ensure blades are not resonating.
- The nozzles should be securely fixed in their desired position on completion of commissioning.

(b) Horizontal Nozzled Models - Remove packaging and secure the 90° Duct Outlet to the outlet on the heater using the bolts supplied.

Secure the nozzle spigot plate to the duct outlet using the bolts and prevailing torque nuts provided. Fit the securing brackets to each of the outlet nozzles, and lift the complete heater assembly and position on the pre-sited purpose built supports. Finish off the assembly by fitting and securing the outlet nozzles to the spigots by way of previously fitted brackets.

2.5 Flue Installation

An integral flue spigot is fitted to all Cabinet Heaters thereby allowing the flue to connect directly to the heater.

The design of the flue must ensure that it can be disconnected to allow for cleaning and servicing, furthermore, all of the flue section joint sockets must face upwards, and the seal between the sections achieved through mechanical joints or through the use of approved caulking string and grout.



It is strongly advised that BS 5854 and BS 5440 parts 1 and 2 are referred to. See also terminal details on page 15 & 16

Where condensation is likely to be a problem provision should be made preferably at the design stage (see section 1.13)

2.6 Oil Installation/connection

The oil tank must be positioned so that there is a fall of 7.5mm (+/- 2.5mm) for every 30mm away from the outlet and towards the sludge/drain valve, which must be sited at the lowest point in the tank. If the tank is positioned on supports then there must be an adequate protective layer between tank and support to prevent damage or deterioration through corrosion.

It is strongly suggested that reference is made to BS 5410 ; part 2 ; 1978.

It is also suggested that the installer is familiar with the detail and requirements contained within sections 1.9 of this manual prior to commencing installation.



Prolonged exposure and contact with Gas Oil can result in the natural oils being removed from the skin, sensitisation can result in dermatitis.

Always ensure that the appropriate personal protective equipment is used.

2.7 Electrical Installation/connection

Cabinet heaters are available either for 415V 50Hz 3PH or 230V 50Hz 1PH supplies depending upon the model specified.

It is recommended that reference is made to the wiring diagrams contained within section 2.11 of this manual prior to installation or connection to the supply. The electrical supply must be as specified and suitable for the heater, and must be run within conduit to a point adjacent to the heater, and be terminated to provide an isolation point that will prevent remote or inadvertent activation.

Cables, conduit, and fittings that are used to make the connection between the isolator and the heater must conform to the appropriate IEE regulations.

All heaters are supplied fused and pre-wired, all must be earthed.

Final connections for any additional external controls must be completed on site, and must be carried out according to IEE regulations.

Separate user information is provided for the time control unit and the burner, and forms part of the product information pack which accompanies every heater when despatched.



Always isolate from mains electrical supply before commencing work on the heater.
Always ensure that the appropriate personal protective equipment is used.

2.8 Air Distribution Installation

The materials selected must be of low heat capacity, and it is preferable that all warm air ductwork is thermally insulated.

Where ducting may be subject to deterioration from exposure to moisture or high humidity material selection and insulation are prime considerations. Joints and seams must be airtight and fastened securely and designed to remain so, even when operating at high temperatures.

Adequate support must be designed into the layout of the ductwork to ensure that the integrity of the seams and joints is maintained. The support must be independent and separate from the heater and the ducting, to allow for free movement during expansion and contraction.

Where ducting passes through walls or partitions sufficient clearance must be left, irrespective of any fire stop requirement, to allow for expansion and contraction. Failure to adhere to these latter two points can result in the generation and transmission of excess noise.

Where ducting is installed in concrete flooring a permanent membrane must be used to isolate the ducting from the corrosive effect of the alkaline salts within the concrete. Care should be taken to ensure that soft insulation material does not become compressed and thereby lose its insulation effectiveness.

2.9 Warm Air Registers

In order that vertical temperature gradients are minimal thereby providing a more even heat distribution, it is preferable to install warm air registers at low wall levels or at floor level, with the size, number, and position commensurate with the requirement of the application.

To minimise noise levels the registers should be set away from corners, additionally, a good seal between the register frame and the wall is important, particularly on high level positions, if unsightly staining through warm air/particulate deposition is to be avoided.

2.10 Heater Control Installation



Isolate heater from mains before undertaking any electrical work.

Unless specified all Cabinet Heaters are manufactured and supplied with a pre-wired Control panel as standard. Optional remote controllers are available to be wired back to the cabinet heater.

Refer to Controller instruction manual for full installation details.

A commissioning switch is provided on all cabinet heaters fitted with a remote controller.

See following section for individual wiring diagrams.

The controls for Horizontal Cabinets and Reverse Flow are supplied as remote option as standard.

Wiring diagram 6045052
 60-85 Hi Lo Riello Burner
 Remote SC3-MZ
 230/50/1ph

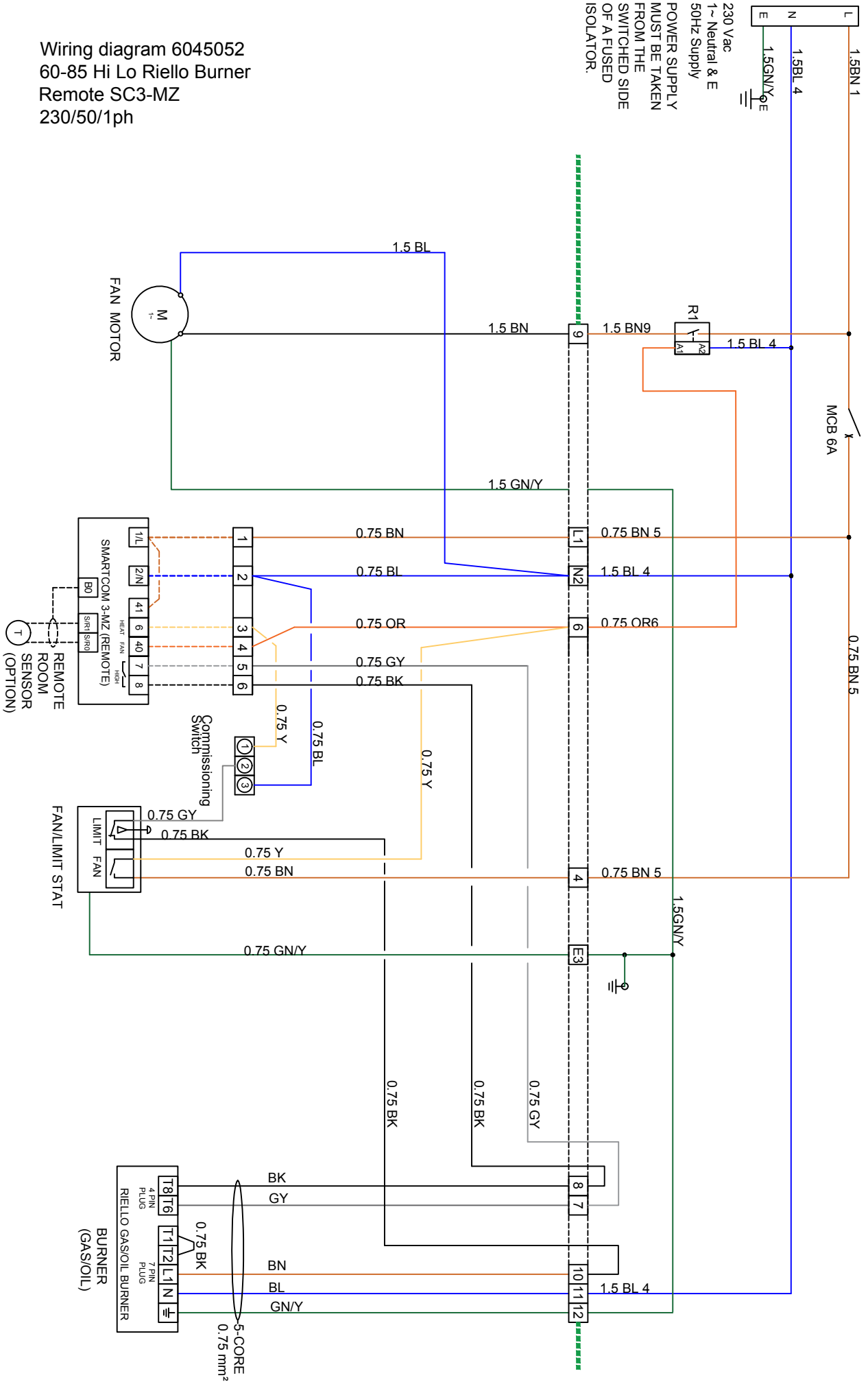

Wiring diagram 6045055
 30-40 Hi Lo Riello Burner
 Remote SC3-MZ
 230/50/1ph

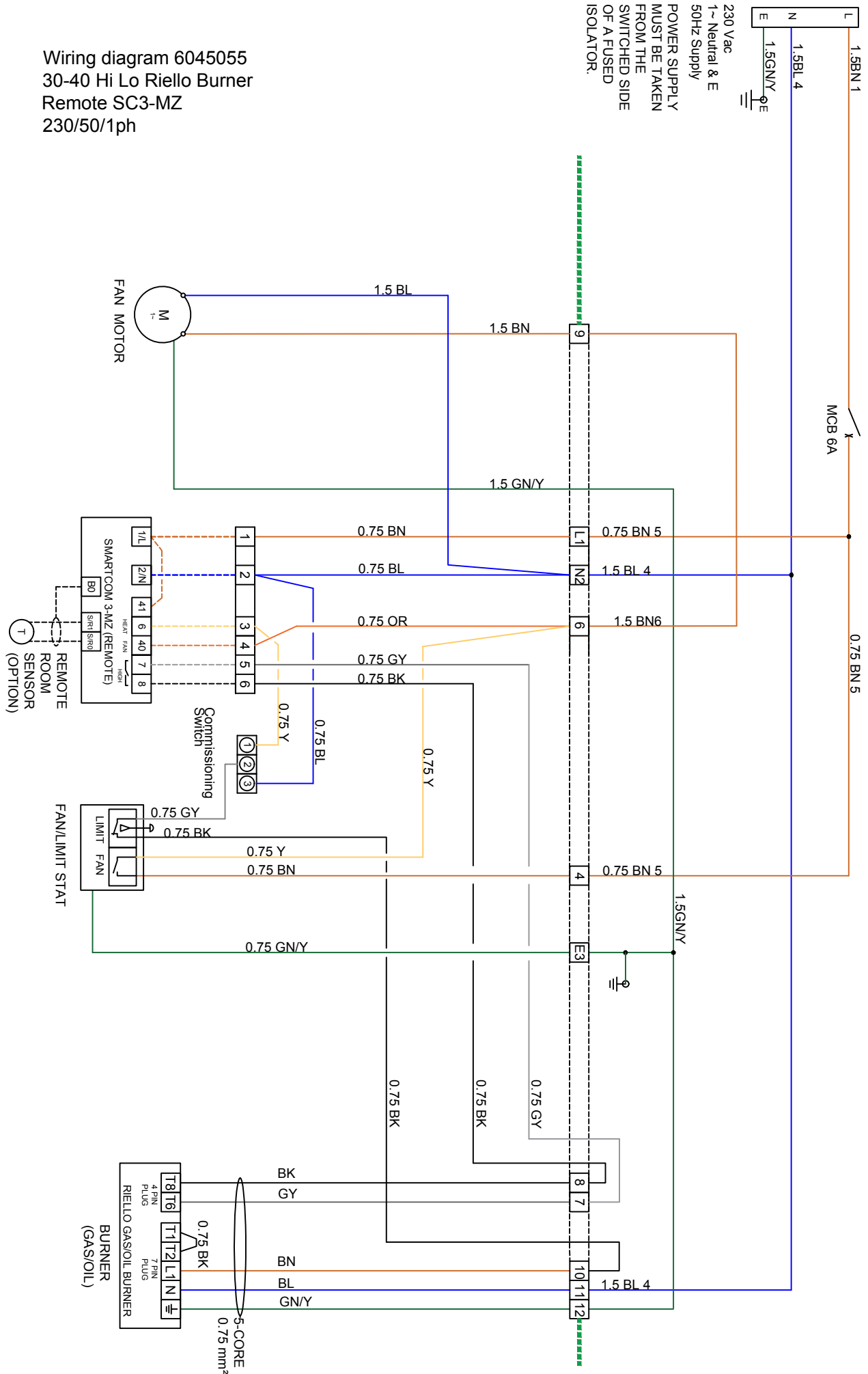

230 Vac
 1 ~ Neutral & E
 50Hz Supply
 POWER SUPPLY
 MUST BE TAKEN
 FROM THE
 SWITCHED SIDE
 OF A FUSED
 ISOLATOR.

Wiring diagram 6045056
 30-40 Hi Lo Riello Burner
 Integral SC3-MZ
 230/50/1ph

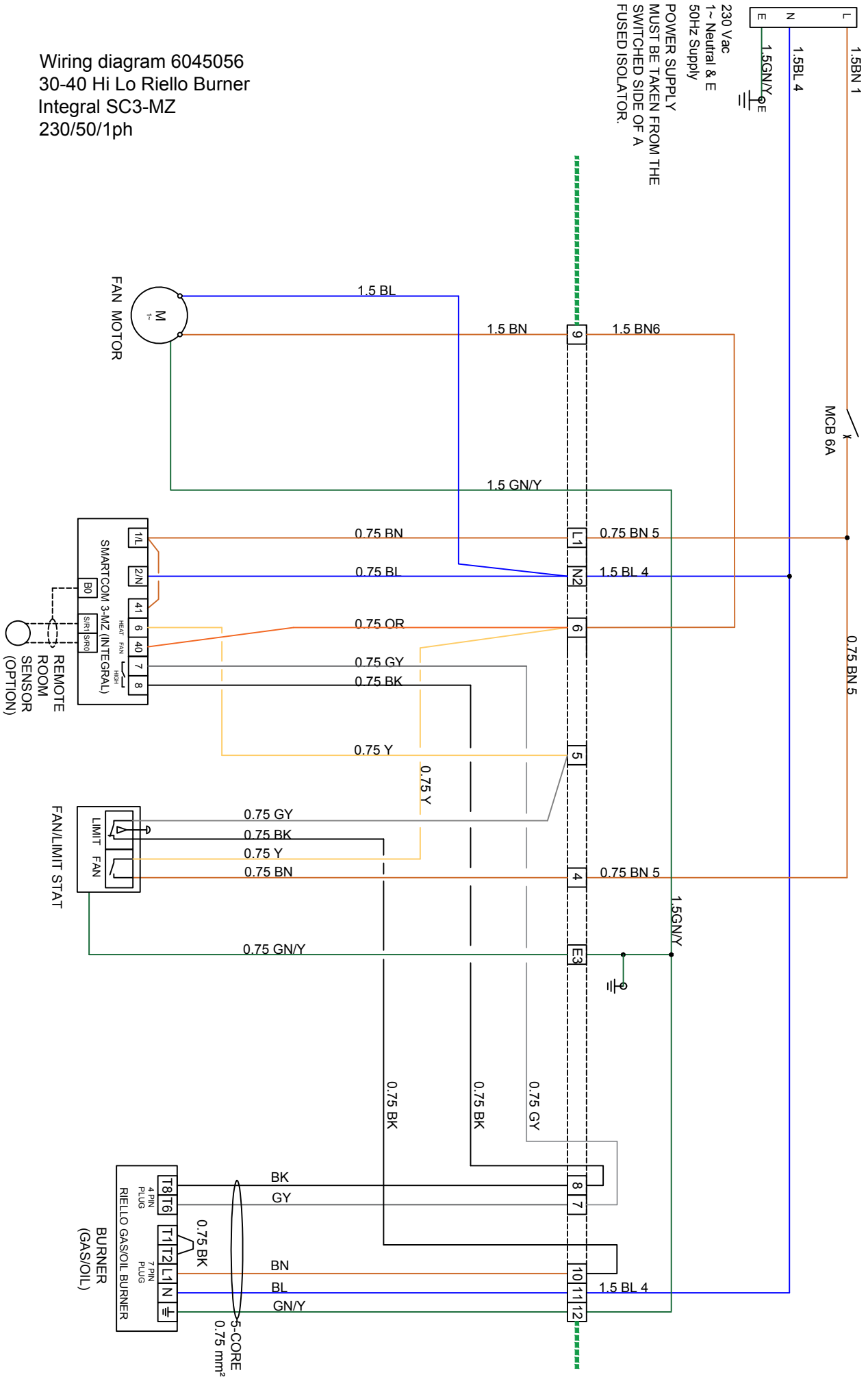

Wiring diagram 6045057
 235-300 Hi Lo Gas Riello Burner
 Remote SC3-MZ
 415/50/3ph

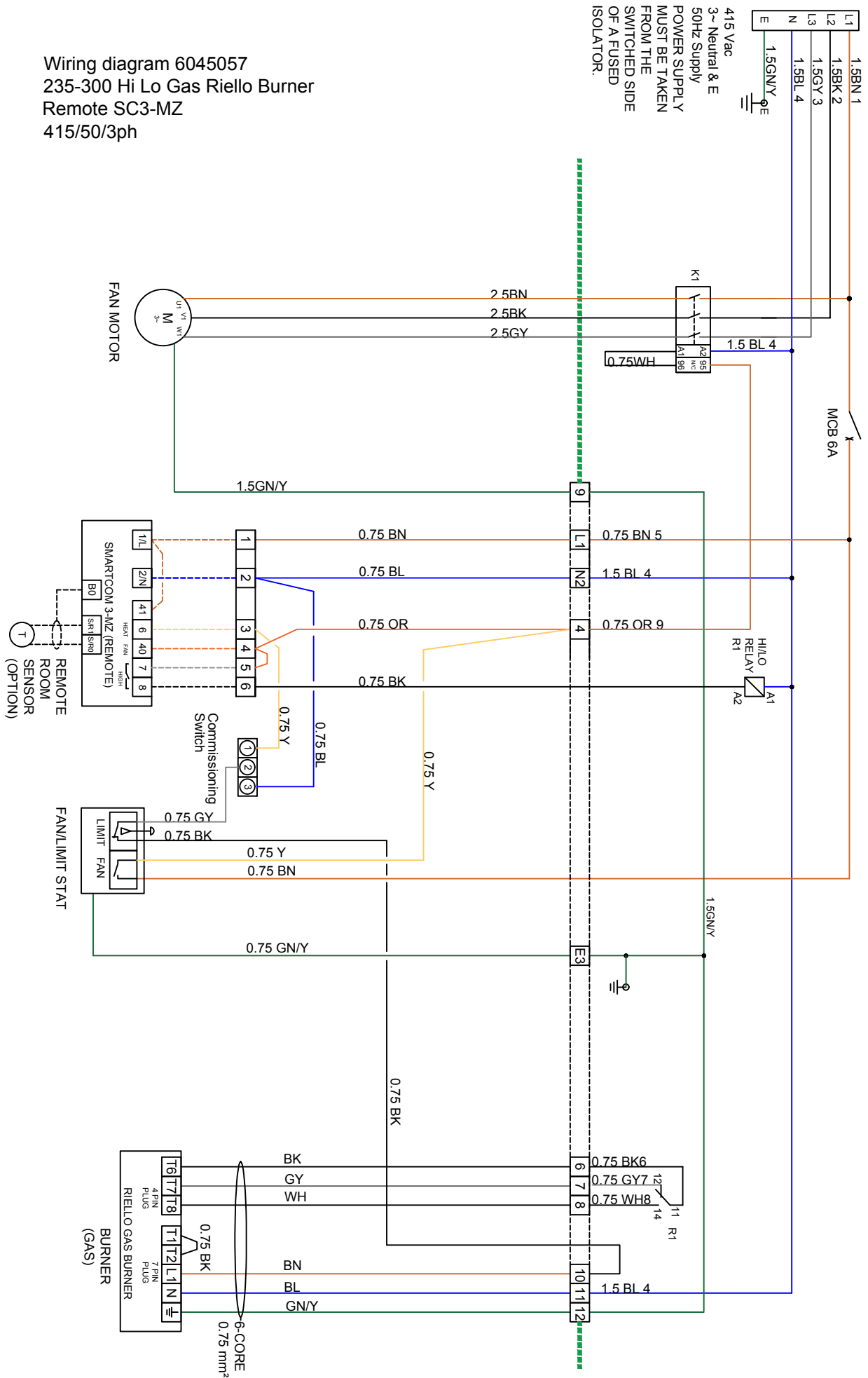

415 Vac
 3 ~ Neutral & E
 50Hz Supply
 POWER SUPPLY
 MUST BE TAKEN
 FROM THE
 SWITCHED SIDE
 OF A FUSED
 ISOLATOR.

Wiring diagram 6045058
 235-300 Hi Lo Gas Integral Burner
 Remote SC3-MZ
 415/50/3ph

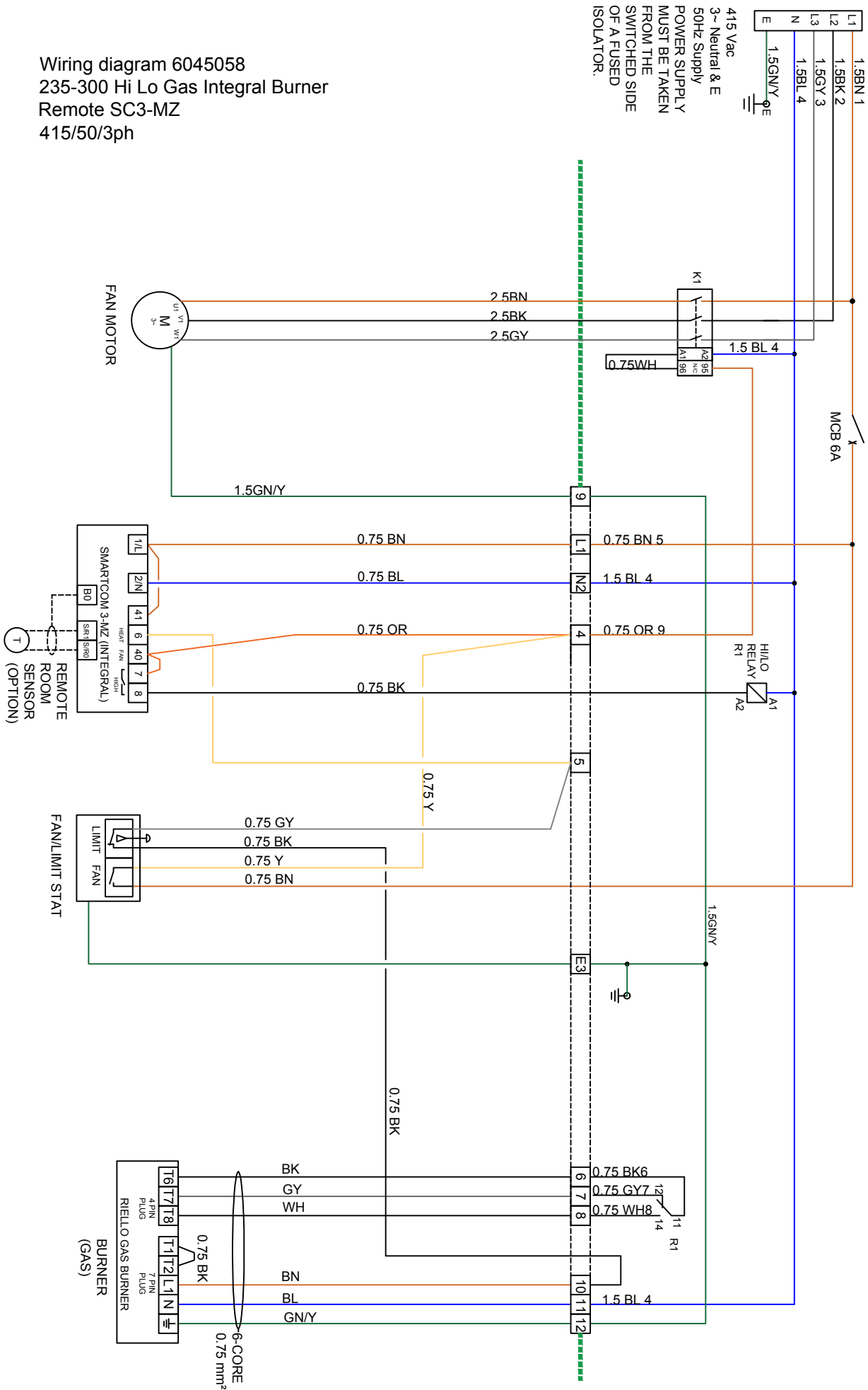

Wiring diagram 6045059
 375 Hi Lo Gas Riello
 Burner Remote SC3-MZ
 415/50/3ph

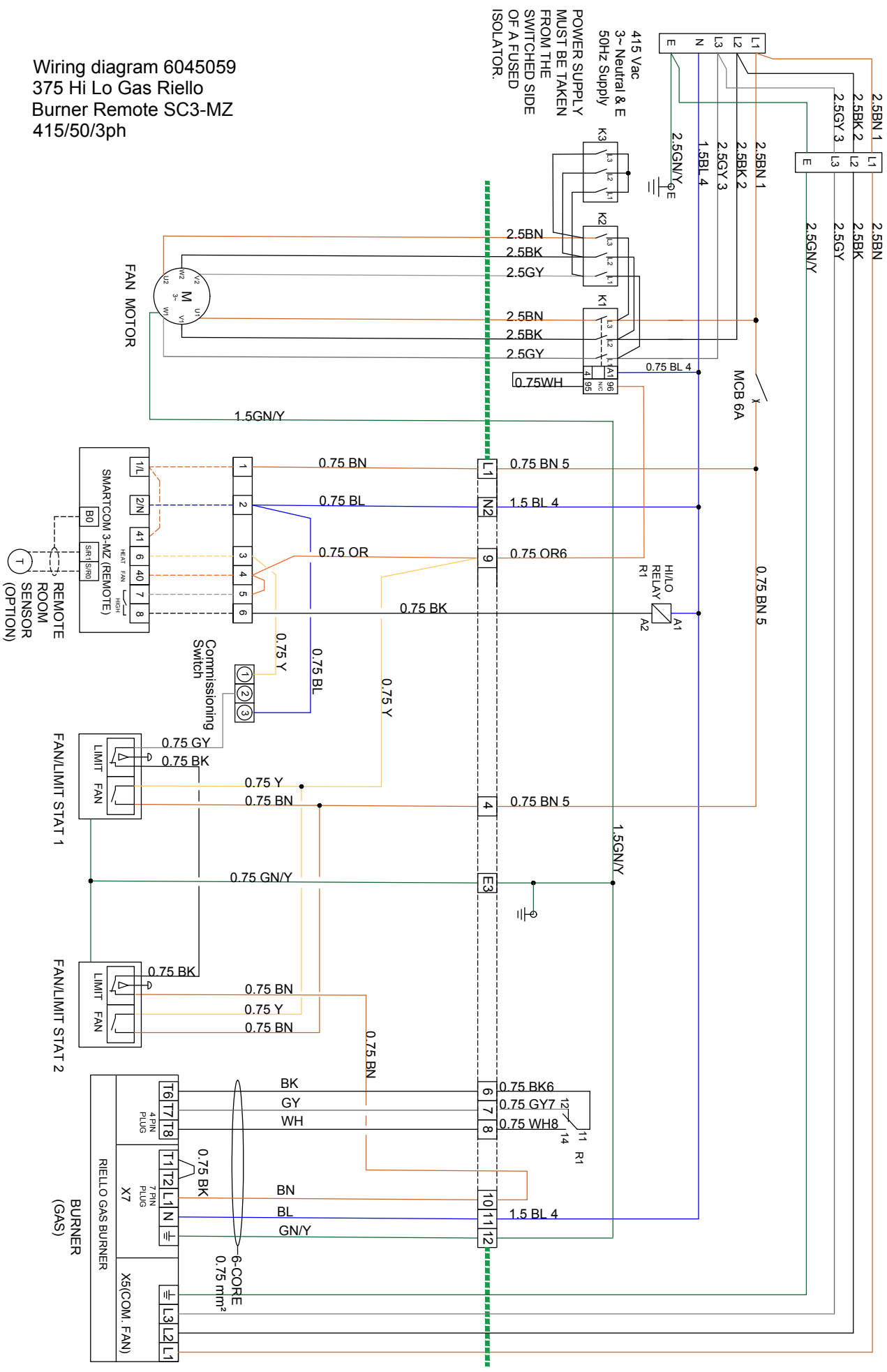

Wiring diagram 6046042
 120-205 Hi Lo Riello Burner
 Remote SC3-MZ
 415/50/3ph

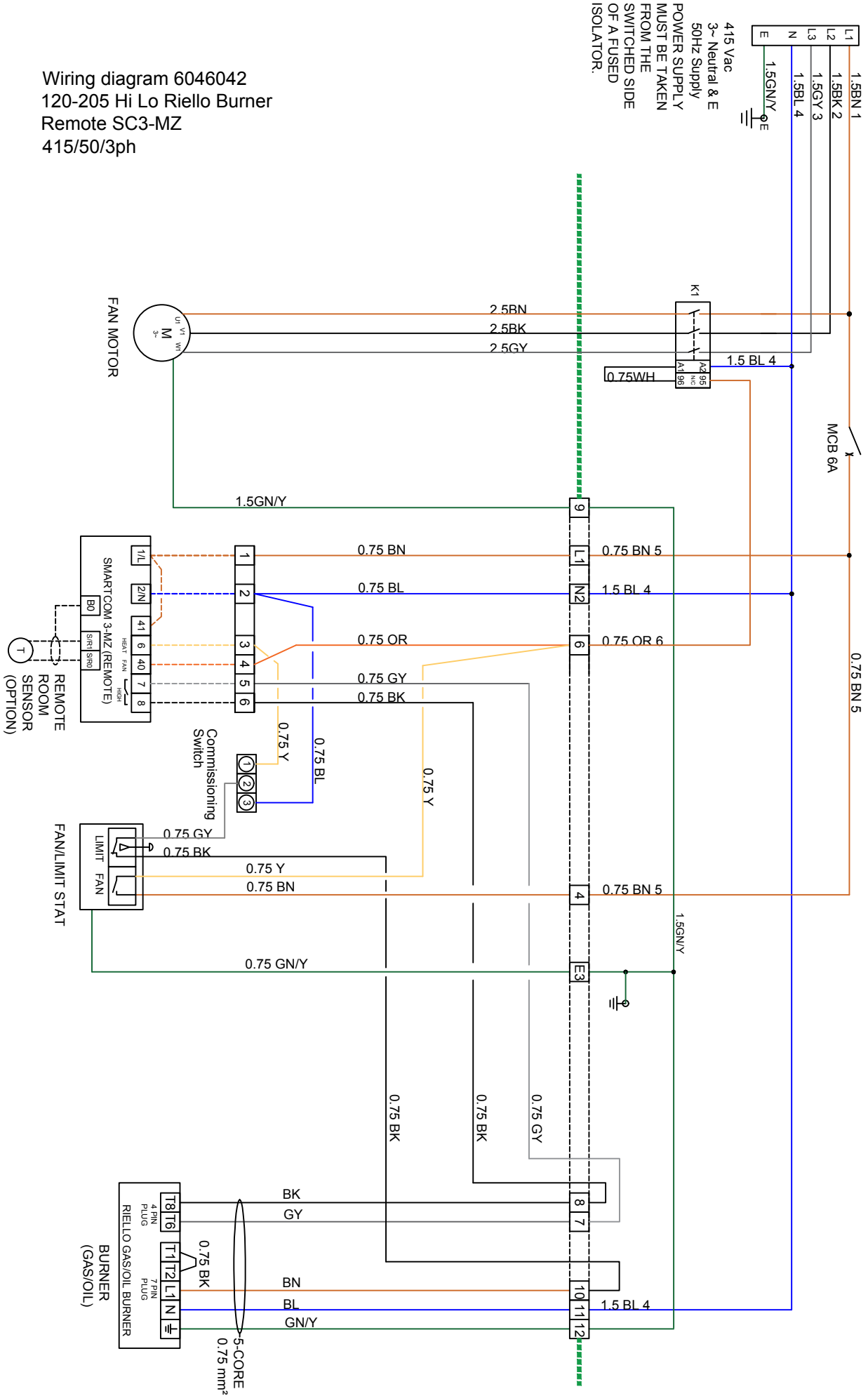

415 V ac
 3~ Neutral & E
 50Hz Supply
 POWER SUPPLY
 MUST BE TAKEN
 FROM THE
 SWITCHED SIDE
 OF A FUSED
 ISOLATOR.

Wiring diagram 6046044
 120-205 Hi Lo Riello Burner
 Integral SC3-MZ
 415/50/3ph

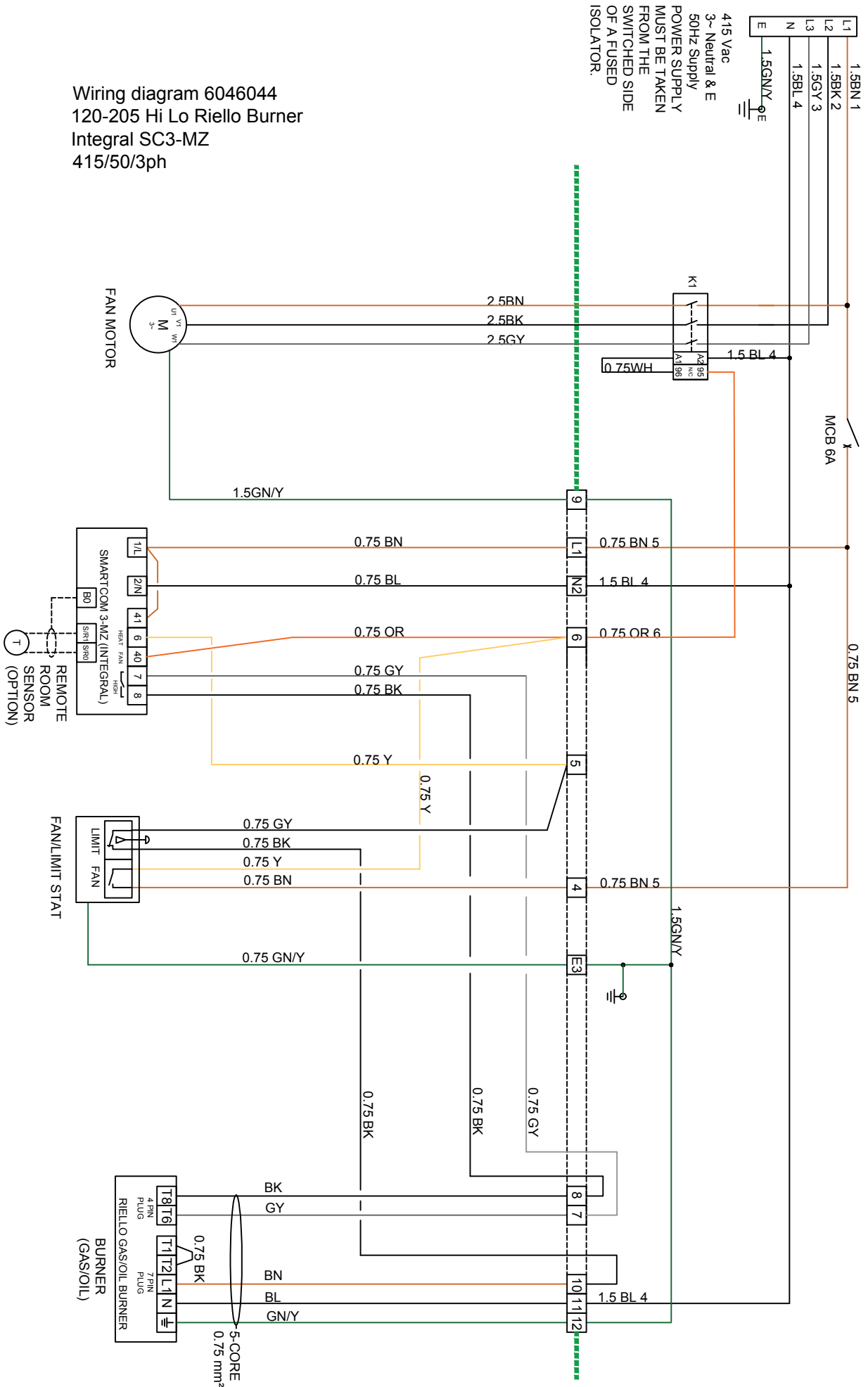

Wiring diagram 6046048
 120-135 Hi Lo Riello Burner
 Integral SC3-MZ
 230/50/1ph

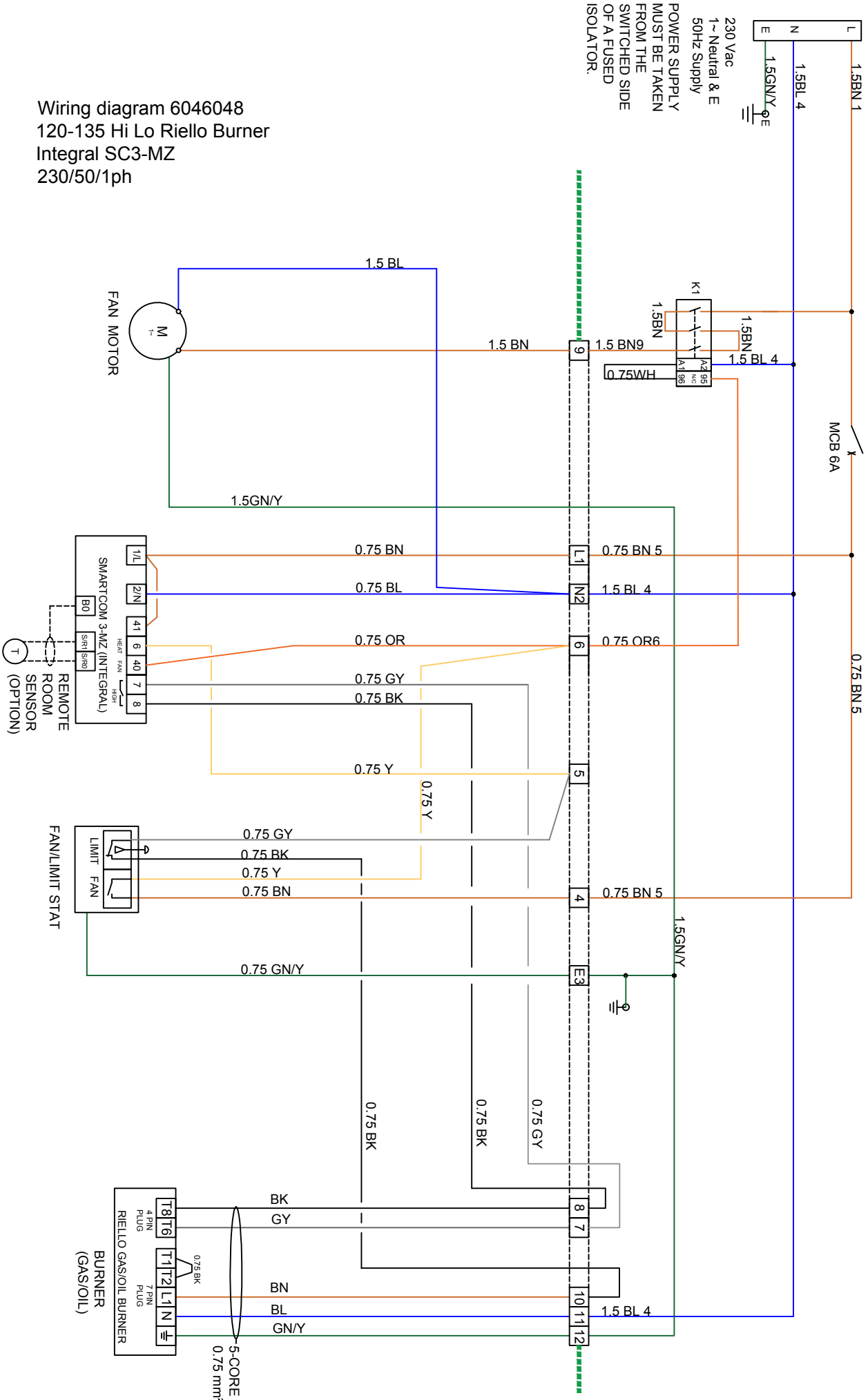

Wiring diagram 6046049
 120-205 Hi Lo Riello Burner Less
 Control
 415/50/3ph

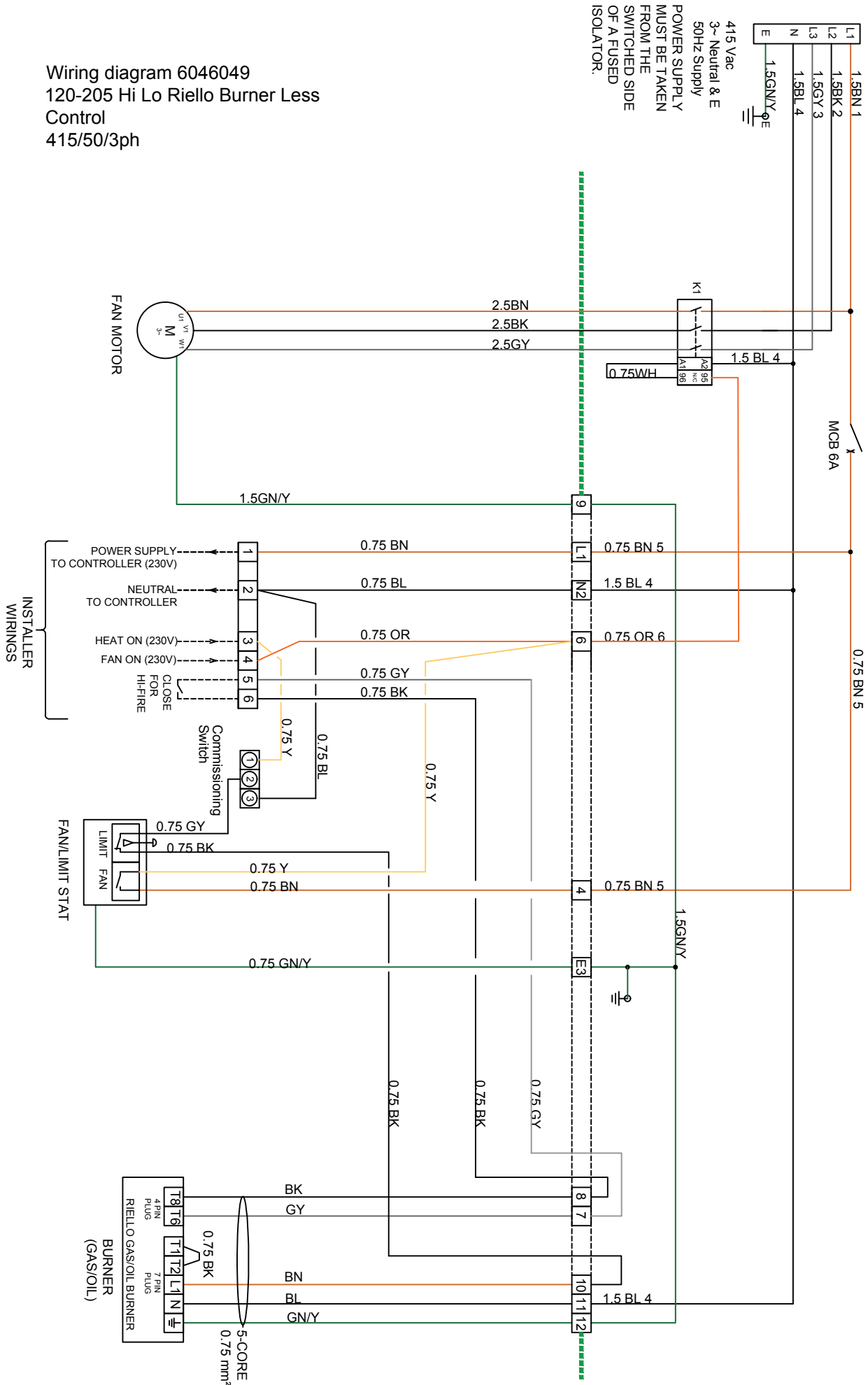

3. Commissioning.



It is a requirement that only suitably qualified and competent personnel are allowed to undertake the commissioning of the heater.



It is also strongly recommended that prior to commissioning the engineer familiarises himself with; the information contained within the information pack that accompanies the heater, the heater itself, and with the specific requirements of the installation /application.



All Cabinet Heaters undergo a rigorous test programme prior to being despatched, whilst such a programme does involve pre-commissioning and setting up the heater to operate efficiently and well within its designed operational limits, this does not mean that on site commissioning is less important than might otherwise be the case.

The idiosyncrasies of each installation can only ever be allowed for, through the use of thorough on site commissioning carried out by trained and experienced personnel equipped with the correct tools and apparatus.



It is strongly recommended that equipment used for the sampling and analysis of flue gases is accurate to within +/- 0.1% and maintained so that it is regularly calibrated.

3.1 Commissioning - Pretest

Check to ensure electrical safety, and inspect and check the oil installation, testing for leaks.

- a. Ensure that the electrical supply is turned off.
- b. Ensure that the oil supply is turned off.
- c. Check that all panels and fasteners are secure and in place.
- d. Check that the heater is installed so that it is square and that the support is adequate.
- e. Ensure that warm air delivery outlets are open and that ducting is adequately supported.
- f. Ensure that if filter assemblies are fitted that they are secure and correctly located.
- g. Check that air inlets are clear and that return air paths are adequate.
- h. Ensure that the flue is secure, adequately supported, and that the various joints are properly sealed.
- i. Check that condensate trap and drain facilities are adequate.
- j. Check that there is provision for flue gas sampling and that this sample point can be plugged and sealed after commissioning.
- k. Check that the fan stat settings has not been disturbed.
- l. Remove lower panel and check motor and fan drive system for integrity of joints, check pulley alignment, fan rotation, and belt tension (see section 3.2).
- m. Ensure that the burner is securely attached to the heater.
- n. Test for electrical earth continuity between the heater, oil pipe work, and mains supply.
- o. Turn on main electrical supply.
- p. Enable fan on via controller by selecting 'Fan only'; 'Vent only'; 'Vent/Manual'.* (* dependent on control type supplied. Refer to individual controller operating manual.)
- q. Check to ensure burner is off but power remains to the fan. The fan will start enabling fan direction etc to be verified. Reset Fan on/standby switch to off.
- r. Set room thermostat and time clock to 'demand' positions.
- s. Turn mains electrical supply to off, replace and secure lower louvered panel covering fan and motor assembly.

3.2 Commissioning - Ignition



Do not proceed with commissioning unless all the criteria detailed within sections 3.0 and 3.1 have been satisfied.

- a. Ensure the electrical supply is turned off.
- b. Ensure that the Oil supply is turned off.
- c. Turn on main electrical supply.
- d. Enable burner via controller by selecting 'Heat' (Relay 2); 'Heat On'; 'Heat/Auto'. * (* dependent on control type supplied. Refer to individual controller operating manual.)
- e. Select 'on' position for heater on/standby switch.
- f. Check for the following burner sequence on the right
- g. Set heater on/standby switch to standby position
- h. Attach oil manifold (bleed screw and pressure gauge)
- i. Open oil supply valves and bleed air from pipe work and adjust burner oil pressure as per detailed in burner manual (section B)
- j. Repeat steps 3.1 q, and 3.2 c,e,f.



It is strongly recommended that the separate manual concerning the operational details of the burner supplied with the heater as part of the information package is studied prior to commissioning.

Time intervals within the ignition sequence will vary slightly from one model to another.



If burner ignition is not satisfactorily accomplished, commissioning must not proceed until the reason or fault has been identified and rectified, if necessary by reference to the separate burner information or to section 6 of this manual.

- k. Repeat steps 3.2 c, a,
- l. Repeat steps 3.2 d,e,f, allowing the heater to reach thermal equilibrium.
- m. Adjust room thermostat to its highest setting, and allow the heater to continue to fire.
- n. Gradually reduce the temperature setting on the room thermostat until the burner shuts down, (@ < ambient and then gradually increase the temperature setting on the thermostat until heat is called for, (@ > ambient) and the burner automatically re-fires.
- o. Re-set time clock to a minimum off period, checking that the burner shuts down, and then automatically re-lights once the minimum off period has elapsed (Separate information on the time clock is contained within the information package supplied with the heater).
- p. Check limit stat by tripping the fan motor overload re-set by pressing the reset button on the overload, located on the heater electrical panel. The time between the fan stopping and burner shut down should be noted (90 seconds max), once the burner has shut down the overload on the motor should be released.
- q. Undertake flue gas analysis using approved and calibrated analysing equipment recording data on the commissioning card, ie, CO, CO₂, net and gross flue temperatures.

Record burner oil pump pressure, ambient temperature, barometric pressure, and smoke reading (0 - 1 Baccarach scale).

Note (i)

The burner air and oil pressure settings should be only very finely adjusted to achieve a CO₂ reading of 12.5% (+/- 0.5%).

Note (ii)

The gross efficiency must be approximately 80% sample taken at 1m above the flue spigot point.

Burner Sequence

Interval	Operation
1 <5s	Combustion air damper actuated, burner fan motor initiates purge cycle.

2 <40s	Solenoid valve opens ignition transformer provides spark for burner ignition
--------	--

EITHER

Interval	Operation
3 >15s	Ignition failure caused by oil starvation resulting in burner lock-out/shutdown

OR

Interval	Operation
3 >15s	Pilot ignition
	Burner Ignition
4 <20s	Burner ignition cycle complete

Note (iii)

All Cabinet Heaters are test fired and pre-commissioned as part of the manufacturing process, if however, during on site commissioning the data are found to be not in accordance with the manufacturers data, then the following action is recommended.

- * Re-check all readings and calculations.
- * Adjust burner as per manufacturers instructions.
- * Consult the Technical Department, details on rear page.
- r. Complete commissioning card and provide operating instructions for the user, high-light the fact that the manufacturer recommends that in the interests of safety and efficiency the heater is serviced on a regular basis only by qualified and competent persons.

The completed commissioning card must be returned to the supplier (details on rear page) immediately after the satisfactory completion of commissioning, failure to do so can invalidate any subsequent warranty claim.

- s. Set all controls to the requirements of the user.

3.3 Commissioning - air delivery system

On free blowing applications the integrity of the fastenings on the heater top and outlet nozzles must be checked. Final adjustment for the direction of the air flow from the nozzle hoods should be made, and the hoods should be secured in the required position by drilling through the two holes provided in the hood outer ring and fastened in place using self tapping screws.



On ducted applications it is necessary that the system is balanced in order to optimise the efficiency of the heater and the air distribution and delivery system Failure to balance the system can result in fan motor overloading and premature component failure, it can also result in an inefficient heating/ventilation system.

Check that the amount of fan produced air volume is in accordance with the heater specification, if the volume is too great the fan can be overloaded. Ensure that the running current is as per that stated on the heater data plate.

Alternatively, the static pressure should be measured at the start of the ductwork to confirm that it is within the permissible tolerance.

- (b) If the current drawn is greater than the stated running current, in most probability this will be caused by insufficient static pressure within the ductwork, in which case system resistance should be increased through the introduction of a damper placed as close to the start of the ductwork as possible, thereby resulting in a reduction in drawn current.

The damper should be adjusted until the current is in accordance with that stated on the data plate.

- (c) If the current drawn is too low the duct outlet grilles will require opening to reduce static pressure and increase air volume, if this is not the case overheat cut outs can be caused.



The Fan Belts must be rechecked on completion of commissioning ensuring that the tension is correct and the pulleys are in alignment

3.4 Commissioning - hand over

- a. (a) Upon full and satisfactory completion of commissioning, a record of commissioning information (contact, date, etc) should be left with the heater, a copy of which must also be forwarded to the supplier (details on rear page)
- b. (b) The commissioning engineer must ensure that the user is familiar with the safe and efficient use of the heater, detailing the function of all controls, and main components.
- c. (c) The user should be made aware of the following in particular
 - (i) Lighting, shutdown, and operational information.
 - (ii) Safety features, data plate, and labelling.
 - (iii) The requirement for regular inspection - especially if the heater is within a more demanding environment - and the need for regular servicing carried out by competent and qualified persons.
- d. (d) Section 8 'User Instructions' should be left with the customer upon satisfactory completion of the commissioning and hand-over.



After approximately 100 hours of running, the tension of the fan belts must be checked to ensure that they are correct and that they have not stretched. See section 4.2.5 for further instructions.

4.0 Servicing.

Servicing must be carried out on a regular basis, the maximum interval between services being 1 year.



It is a requirement that only suitably qualified and competent persons are allowed to undertake servicing.



Before any maintenance or servicing work is carried out the heater must be shut down and allowed to cool, and have the oil and electric supplies to it turned off at the supply valve and isolator respectively.



Certain component parts are factory sealed and are designed so as to be tamper proof. Usually such items do not require servicing, and therefore should not be tampered with.

Failure to comply with this can invalidate any warranty, and can also lead to premature failure.

The following parts fall within this category: room thermostat, time clock, frost thermostat, sequential controller, and fan and motor.

Reference should be made to the separate information covering the operational details of the burner and timer.

Only approved spare/replacement parts can be fitted, failure to comply with this can compromise the safe and efficient running of the heater, and can also invalidate any warranty claim.

4.1 Planned Servicing

In order to maintain the efficient operation of the heater it is recommended that the following planned servicing and preventative maintenance programme is adopted by the user.

4.2 Servicing Procedure - Major Component Parts

Quarterly Inspection

- (a) Visual inspection of the burner
- (b) Clean and check spark electrode
- (c) Clean and check photocell
- (d) Check overheat safety is operational

Bi-Annual Inspection

- (a) As per quarterly inspection, plus...
- (b) Combustion check
- (c) Smoke test

Annual Inspection

- (a) As per half year inspection, plus...
- (b) Heat exchanger and cleaning
- (c) Electrical connections
- (d) Main fan motor
- (e) Main fan assembly
- (f) Pulleys
- (g) Fan belts
- (h) Oil supply including filter
- (i) Burner
- (j) Air delivery system
- (k) Flue
- (l) Report

4.2.1 Flue

A visual inspection should be carried out to ensure that the flue remains adequately supported, both internally as well as externally, and that the various joints are effectively sealed.

Inspection covers, where fitted, should be removed and the flue checked to see whether cleaning is required. If inspection covers are not fitted the flue gas exit duct and flue spigot will provide not only an indication of the cleanliness of the flue, but will also enable access for cleaning.

The presence of the flue terminal should be checked. If a condensate trap and drain facility is fitted this should be checked to ensure that it continues to function correctly, and the drainage of condensates is not impaired.

4.2.2 Main Fan Motor

Remove access panel. Dust and other foreign matter should be cleaned by blowing over with compressed air and through the use of a soft bristle brush and cloth. Solvent wipes may be used to remove heavy soiling from the motor casing.

Traces of surplus lubricants spreading from the bearings should also be cleaned away.

Where motors are fitted with grease nipples bearings should be lubricated with the correct grade of lubricant. Motors which do not have grease nipples feature sealed bearings which are lubricated during manufacture for their life.

The electrical connections should be checked as follows.:

- The cover to the terminal box should be removed by undoing the screws which secure it.

Check connections for signs of corrosion, tightness, and ensure that there are no stray strands which could form a short circuit.

Clean, tighten, and replace as necessary. Replace cover and secure.

4.2.3 Main Fan

- Remove dust and other foreign matter by blowing off with compressed air or through the use of a soft bristle brush.
- Check that the bearings do not show signs of excessive wear. It should be noted that these bearings do not require lubricating.

If the bearings require replacing the following procedure should be followed.

- (a) Remove belt(s).
- (b) Loosen set screw on eccentric collar and tap collar in the opposite direction to fan rotation.
- (c) Remove collar and bearing.
- (d) Check shaft for alignment and straightness.
- (e) Locate the bearing in its seat and place on the shaft with the cam facing outwards.
- (f) Fit the eccentric collar and engage the cams.
- (g) Tighten initially by rotating, and then by tapping in the direction of the fan rotation.
- (h) Replace fasteners and secure.
- (i) Turn by hand to ensure free fan rotation.

4.2.4 Pulleys

Check pulleys for alignment using a straight edge, if necessary reposition either or both of the pulleys and the fan motor.

Check for excessive wear within the root and sides of the grooves, and check for any other signs of wear or damage, if necessary replace the pulley as follows.

- (a) Release tension on belts and remove.
- (b) Release the taper locks by slackening the securing screws by several complete turns.
- (c) Fully remove one screw from the taper lock, and having oiled it, insert into the threaded jacking point.
- (d) Tighten screw until the taperlock is free.
- (e) Remove taperlock and pulley.
- (f) Fit taperlock in new pulley, and provisionally position on the shaft.
- (g) Remove the screw from the jacking point, and tighten both screws in their clamping points until the pulley can just be moved on the shaft by hand.
- (h) Align pulleys using a straight edge, and by gradual alternate tightening of the screws clamp in position.
- (i) Refit belts and check for the correct amount of tension.

4.2.5 Fan Belts

- Check belts for signs of wear.
- Frayed or split belts must be replaced using belts with a common batch code.
- Belt tension must be checked, and if on multi-belt units it is found that one belt contains more slack than its accompanying belts, then all the belts on the unit must be replaced, again using a common batch code.

Replacement and tensioning is carried out as follows.



The maximum displacement at the mid point of the top edge of the belt must not be greater than 16mm per metre of span, when a force of 3kg is applied in a plane perpendicular to the belt.

- a. Loosen fan motor securing bolts on chassis.
- b. Loosen fan motor slide adjustment bolt.
- c. Slide fan motor towards fan to slacken belts.
- d. Replace belts, pull fan motor away from fan until belts are tight.
- e. Tighten adjustment bolt to hold motor.
- f. Tighten fan securing bolts ensuring that the fan is square and the pulleys aligned.
- g. Check belt tension, making final adjustments as necessary.
- h. Tighten and clamp fasteners to hold fan motor in position.

4.2.6 Heat Exchanger

The heat exchanger requires a visual inspection at least once per year, this should be accompanied by cleaning.

It is recommended that a flue brush and vacuum cleaner be used to facilitate this. Access to the heat exchanger is gained through the removal of the rear upper panel and heat shield.

Servicing and cleaning should be performed as follows:

- a. Remove brass nuts and cover from heat exchanger end assembly to expose heat exchanger tubes.
- b. Remove any accumulated deposits from the tubes.
- c. Particular attention should be paid to the upper internal surfaces of the tubes, where through convection heavier deposition is likely to occur.
- d. Any deposits which may have accumulated within the combustion chamber can be removed with a vacuum cleaner once the burner is removed.



It is most important that a build up of deposits is not allowed to occur as this can have an adverse effect upon the efficiency of the heater and reduce the life of the heat exchanger.

- e. The heat exchanger and combustion chamber should be visually inspected for signs of splits, cracks, and distortion.
- f. All gaskets should be checked to ensure that they continue to provide a gas tight seal, if there is an element of doubt then they should be replaced.

If the condition of the heat exchanger gives cause for concern the suppliers Service Department should be advised pending a more detailed examination. Details on rear page

4.2.7 Electrical Supply

All connections must be checked to ensure that they are secure, and free from corrosion.

Terminals and connections should also be checked to ensure that no stray strands are bridging terminals.

Electrical continuity should also be checked.

4.2.8 Oil Supply

The oil supply pipe work, tank, and fittings should all be inspected to ensure that they are free from corrosion, and to ensure that where brackets have been fitted these remain secure and offer adequate support.

The oil filter should be replaced with a new one, and the system should be checked for leaks. If the oil level is such to allow removal of any sludge or other contaminants form the tank this too should be undertaken, particularly if there have been problems of poor firing associated with contaminants reaching the burner.

 Any waste oil or sludge must be disposed of correctly. Never dispose of it by dumping or tipping it down drains or into watercourses where ground water can become polluted and environmental damage caused.

4.2.9 Burner

Service requirements for the burner fitted to the cabinet heater are covered in the separate manual prepared by the burner manufacturer.

 It is most important that the burner is serviced regularly and in accordance with the manufacturers instructions.

4.2.10 Air Delivery System

A visual inspection should be undertaken to ensure that the air delivery system is in good order, that it remains adequately supported and that the various joints are effectively sealed.

4.2.11 Report

A full and detailed service report should be prepared, it is advised that the report is not completed until the heater has been re-commissioned, where upon the completed report can then be run through with the user.

4.3 Service Re-commissioning

The heater should be re-commissioned as follows, as per section 3.1 through to section 3.4 inclusive.

This must be regarded as a necessary part of the heater service. By the service engineer.

Turbulator Positions in Heat Exchanger 60 Cabinets. 11 off

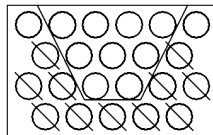

Turbulator Positions in Heat Exchanger 85 Cabinets. 22 off

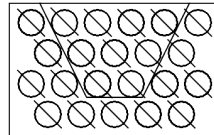

Turbulator Positions in Heat Exchanger 120 & 135 Cabinets. 18 off

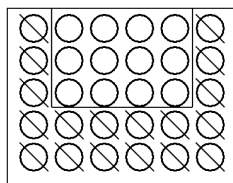

Turbulator Positions in Heat Exchanger 180 & 205 Cabinets. 40 off

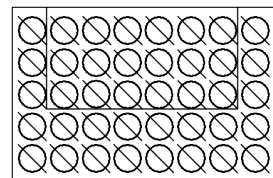



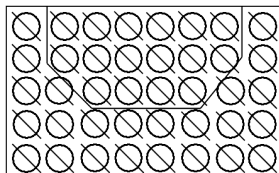



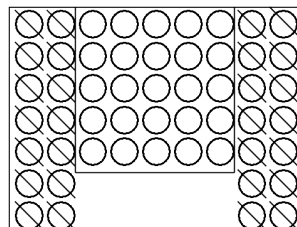









Turbulator Positions in Heat Exchanger 235 & 300 Cabinets. 40 off

















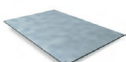













Turbulator Positions in Heat Exchanger 375 Cabinets. 28 off

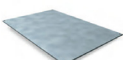

Item	Heater Size /Description	30	40	60	85	120	135
	Burner 35s	29-99-602 RG1RKD	29-99-602 RG1RKD	29-99-603 RG2D	29-99-603 RG2D	29-99-604 RG3D	29-99-605 RG4D
	Burner 28s	29-99-602 RG1RKD	29-99-602 RG1RKD	29-99-603 RG2D	29-99-603 RG2D	29-99-604 RG3D	29-99-605 RG4D
	Burner Gasket	3005787	3005787	3005795	3005795	3005813	3005813
	Nozzle 35s	27-00-409	27-00-437	27-00-438	27-00-430	27-00-032	27-00-040
	Nozzle 28s	27-00-437	27-00-437	27-00-438	27-00-445	27-00-032	27-00-040
	Control Box	3001175	3001175	3001174	3001174	3001174	3001174
	Electrode Assy	3007513	3007513	3007495	3007495	3007495	3007495
	Photocell	3007839	3007839	3007839	3007839	3007839	3007839
	Fire Valve	28-30-102	28-30-102	28-30-102	28-30-102	28-30-105	28-30-102
	Oil Filter	29-15-017	29-15-017	29-15-017	29-15-017	29-15-012	29-15-012
	Rocker Switch Black	28-40-104	28-40-104	28-40-104	28-40-104	28-40-104	28-40-104
	MCB 1ph	28-07-085	28-07-085	28-07-085	28-07-085	28-07-084	28-07-084
	MCB 3ph	n/a	n/a	28-07-084	28-07-084	28-07-084	28-07-084
	Overload 1ph	n/a	n/a	n/a	n/a	28-11-130	28-11-132
	Overload 3ph	n/a	n/a	28-11-125	28-11-125	28-11-127	28-11-128
	Contactor 1ph	n/a	n/a	28-11-137	28-11-137	n/a	n/a
	Contactor 3ph	n/a	n/a	28-11-131	28-11-131	28-11-131	28-11-131
	Fan/Limit Thermostat Assy	20-45-599	20-45-599	20-45-599	20-45-599	20-45-599	20-45-599
	Fan/Limit Thermostat Gasket	20-45-589	20-45-589	20-45-589	20-45-589	20-45-589	20-45-589
	Sight Glass	20-30-151	20-30-151	20-30-151	20-30-151	20-30-151	20-30-151

Item	Heater Size /Description	180	205	235	300	375
	Burner 35s	29-99-606 RG5D	29-99-606 RG5D	29-99-581 RL32	29-99-581 RL32	29-99-556 RL44
	Burner 28s	29-99-606 RG5D	29-99-606 RG5D	29-99-581 RL32	29-99-581 RL32	29-99-556 RL44
	Burner Gasket	3005813	3005813	3003817	3003817	30-03-817
	Nozzle 35s	27-00-032 + 27-00-032	27-00-040 + 27-00-032	27-00-079	27-00-058	27-00-267 +27-00-267
	Nozzle 28s	27-00-032 + 27-00-032	27-00-040 + 27-00-032	27-00-079	27-00-058	
	Control Box	3001174	3001174	3003584	3003584	30-13-071
	Electrode Assy	3007495	3007495	3007617	3007617	30-03-796
	Photocell	3007839	3007839	(UV Flame Detector) 3012135	(UV Flame Detector) 3012135	30-03-779
	Fire Valve	28-30-102	28-30-102	28-30-102	28-30-102	28-30-102
	Oil Filter	29-15-012	29-15-015	29-15-020	29-15-020	29-15-020
	Rocker Switch Black	28-40-104	28-40-104	28-40-104	28-40-104	28-40-104
	MCB 1ph					
	MCB 3ph	28-07-084	28-07-084	28-07-084	28-07-084	28-07-084
	Overload 1ph	n/a	n/a			
	Overload 3ph	28-11-128	28-11-128	28-11-129	28-11-130	28-11-111
	Contactor 3ph	28-11-131	28-11-131	28-11-131	28-11-131	n/a
	Star Delta 3ph	n/a	n/a	n/a	n/a	28-11-045
	Fan/Limit Thermostat Assy	20-45-599	20-45-599	20-45-599	20-45-599	20-45-599
	Fan/Limit Thermostat Gasket	20-45-589	20-45-589	20-45-589	20-45-589	20-45-589
	Sight Glass	20-30-151	20-30-151	20-30-151	20-30-151	20-30-151

Item	Heater Size /Description	30	40	60	85	120	135
	HTX Assy Aluminised S/Steel	31-28-128 31-28-159	31-28-128 31-28-159	20-45-154 20-45-164	20-45-154 20-45-164	20-46-283 20-46-281	20-46-283 20-46-281
	Turbulators	n/a	n/a	20-45-485	20-45-485	20-45-780	20-45-780
	Burner Spigot Gasket	31-28-080	31-28-080	31-40-156	31-40-156	31-27-121	31-27-121
	Stackbox Assembly Painted	31-28-078	31-28-078	31-24-074/Z	31-27-123/Z	37-27-123/Z	31-27-123/Z
	Pressure Relief Gasket	31-28-080	31-28-080	31-27-121	31-27-121	31-27-121	31-27-121
	Flue Box Cover Assembly	31-28-115	31-28-115	20-45-094	20-45-094	20-45-094	20-45-094
	Heatshield Panel Front Rear	31-28-124 31-28-123	31-28-124 31-28-123	20-45-140 20-45-141	20-45-140 20-45-141	20-46-291 20-46-290	20-46-291 20-46-290
	Motorised Fan 1ph Motorised Fan 3ph	28-09-049 n/a	28-09-049 n/a	n/a 20-32-042	n/a 20-32-042	n/a	n/a
	Centrifugal Fan*	n/a	n/a	28-09-086	28-09-086	28-09-003	28-09-003
	Fan Pulley*	n/a	n/a	N6563	N6475	28-65-092	28-65-096
	Fan Pulley Taperlock*	n/a	n/a	N6551	N6551	28-66-125	28-66-125
	Motor 1ph* Motor 3ph*	n/a	n/a	28-10-117	28-10-117	28-10-117 28-10-127	28-10-016 28-10-015
	Motor Pulley*	n/a	n/a	N6701	N6701	N6553	N6553
	Motor Pulley Taperlock*	n/a	n/a	N6128	N6128	28-66-024	28-66-025
	Pulley Belt*	n/a	n/a	N6603	N6603	09-16-110	09-16-106

Item	Heater Size /Description	180	205	235	300	375
	HTX Assy Aluminised S/Steel	20-46-355 20-46-400	20-46-355 20-46-400	20-47-405 20-47-421	20-47-405 20-47-421	20-28-211 20-28-039
	Turbulators	20-46-781	20-46-781	20-47-763	20-47-763	20-47-763
	Burner Spigot Gasket	31-27-121	31-27-121	31-29-046	31-29-046	31-29-046
	Stackbox Assembly Painted	20-46-307/Z	20-46-307/Z	20-47-425/Z	20-47-425/Z	20-28-086/Z
	Pressure Relief Gasket	20-46-354	20-46-354	20-46-354	20-46-354	31-27-121
	Flue Box Cover Assembly	20-46-310	20-46-310	20-47-546	20-47-546	20-28-094
	Heatshield Panel Front Rear	20-46-336 20-46-335	20-46-336 20-46-335	20-47-430 20-47-431	20-47-430 20-47-431	20-28-070 20-28-071
	Motorised Fan 1ph Motorised Fan 3ph	n/a	n/a	n/a	n/a	n/a
	Centrifugal Fan	28-09-004	28-09-004	28-09-043	28-09-043	28-09-087
	Fan Pulley	28-65-105	28-65-105	28-65-074	28-65-075	N6103
	Fan Pulley Taperlock	N6131	N6131	N6131	N6131	N6139
	Motor 1ph Motor 3ph	28-10-117	n/a 28-10-120	n/a 28-10-026	n/a 28-10-021	n/a 28-10-024
	Motor Pulley	N6553	28-65-072	N6100	N6677	N6677
	Motor Pulley Taperlock	28-66-025	28-66-028	28-66-028	N6413	N6413
	Pulley Belt	09-16-126	09-16-126	09-16-116	09-16-116	09-16-138

6. Fault Finding Guide

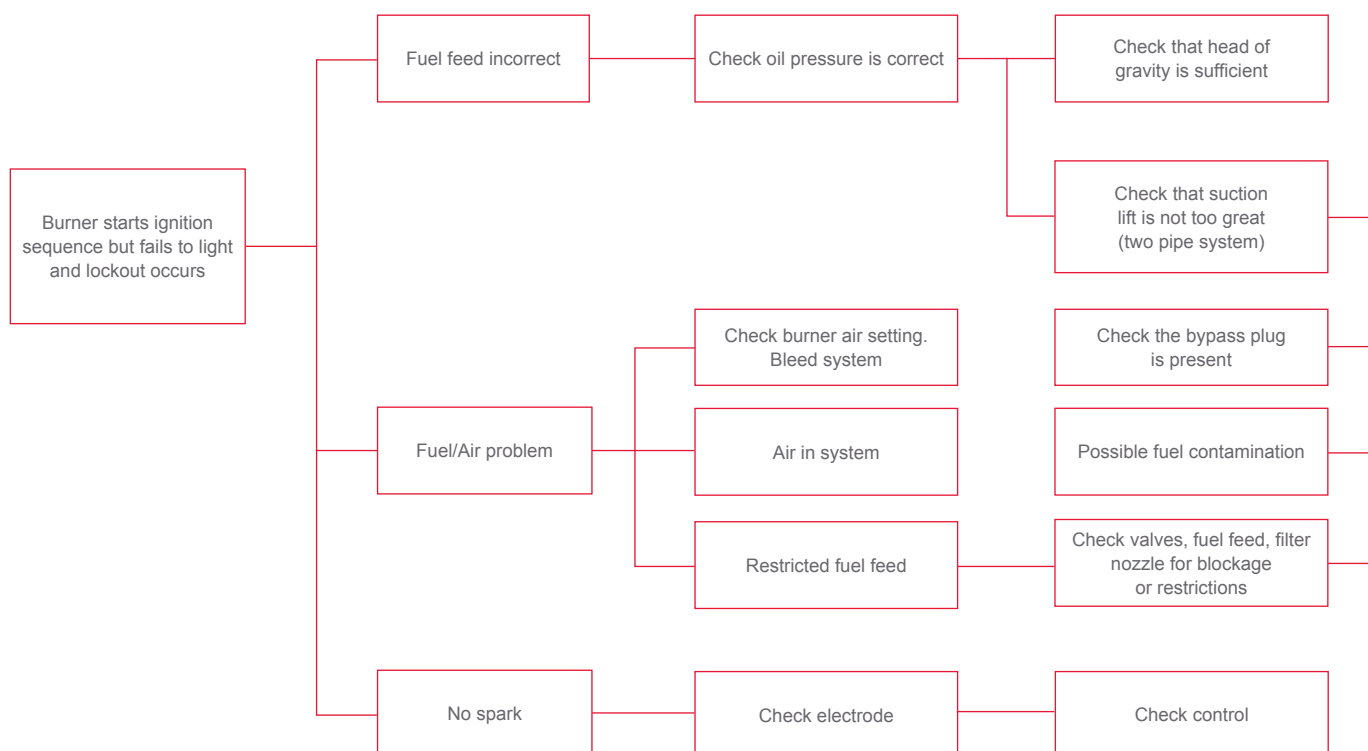
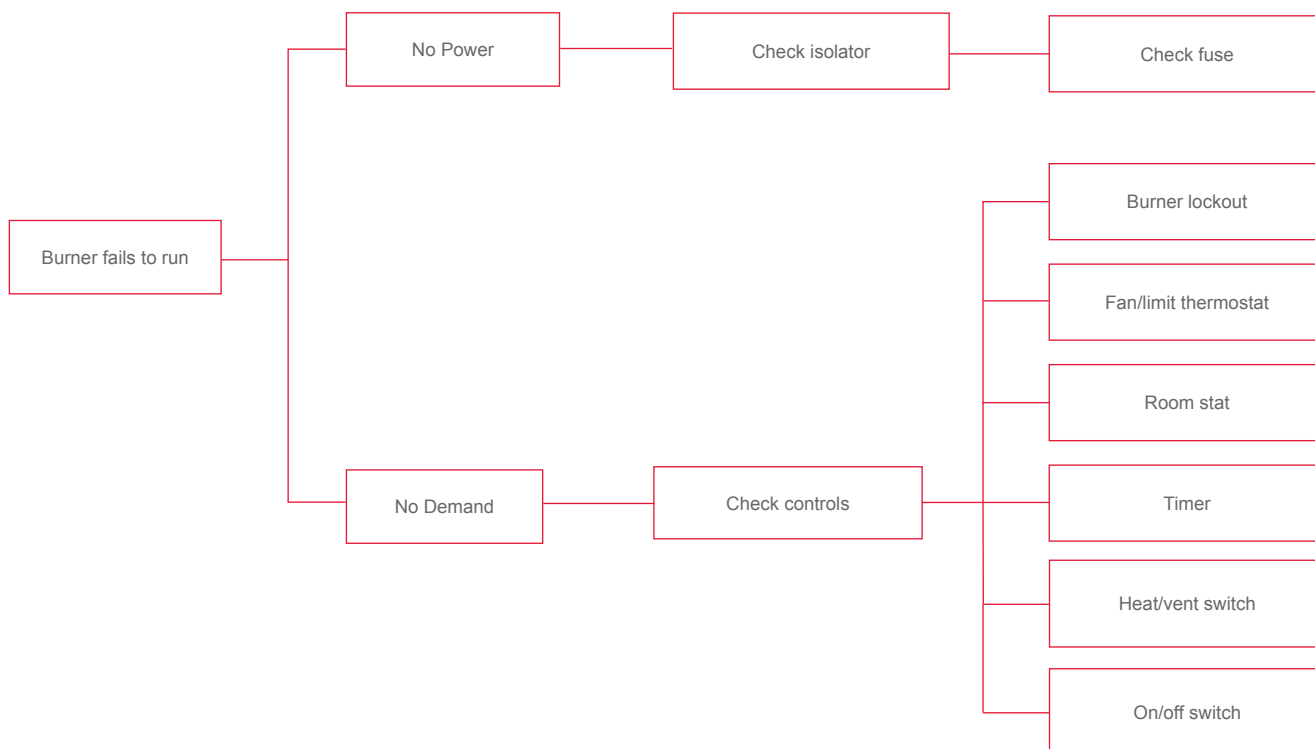

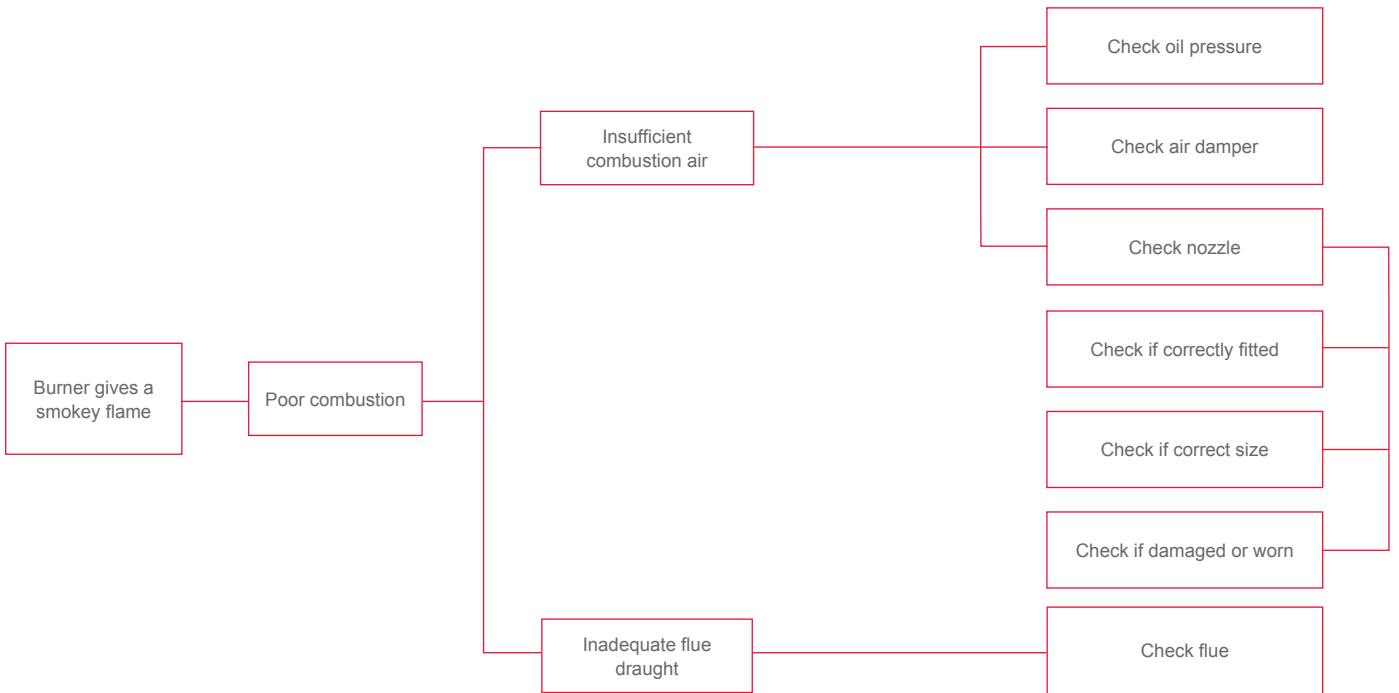
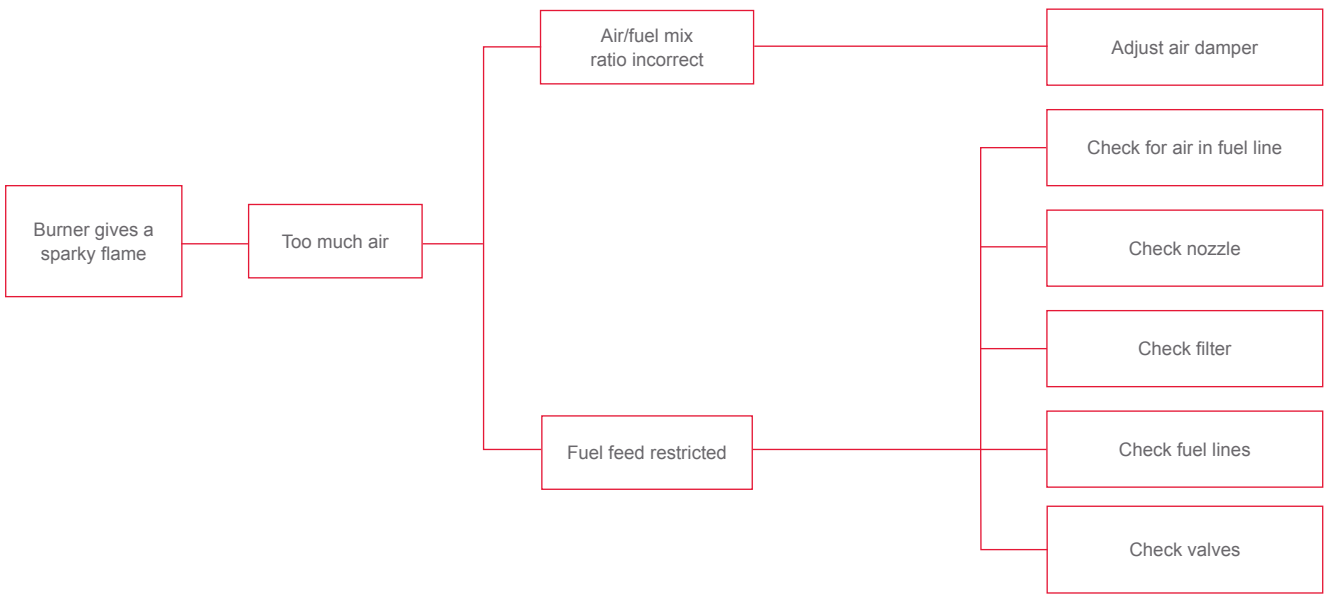

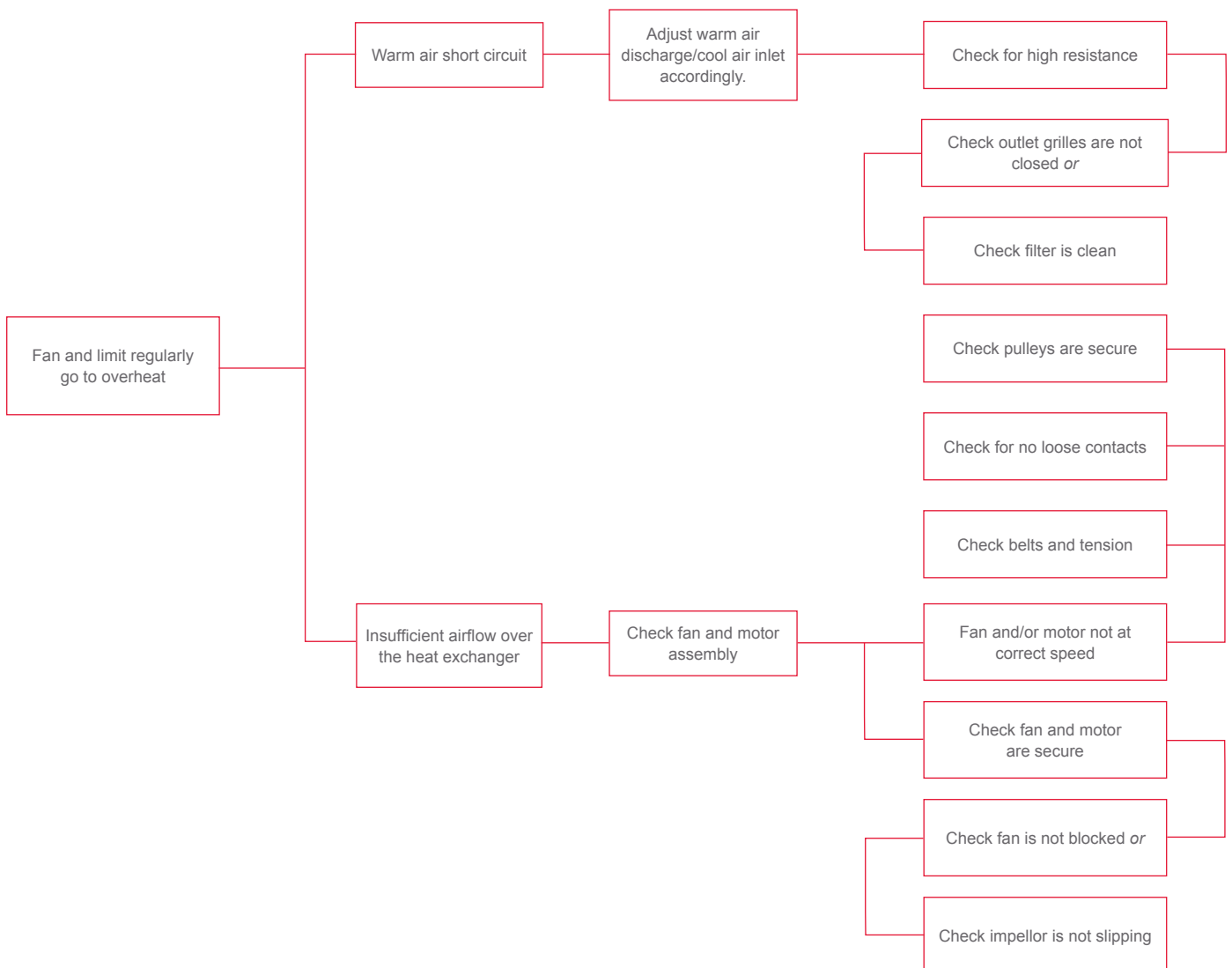
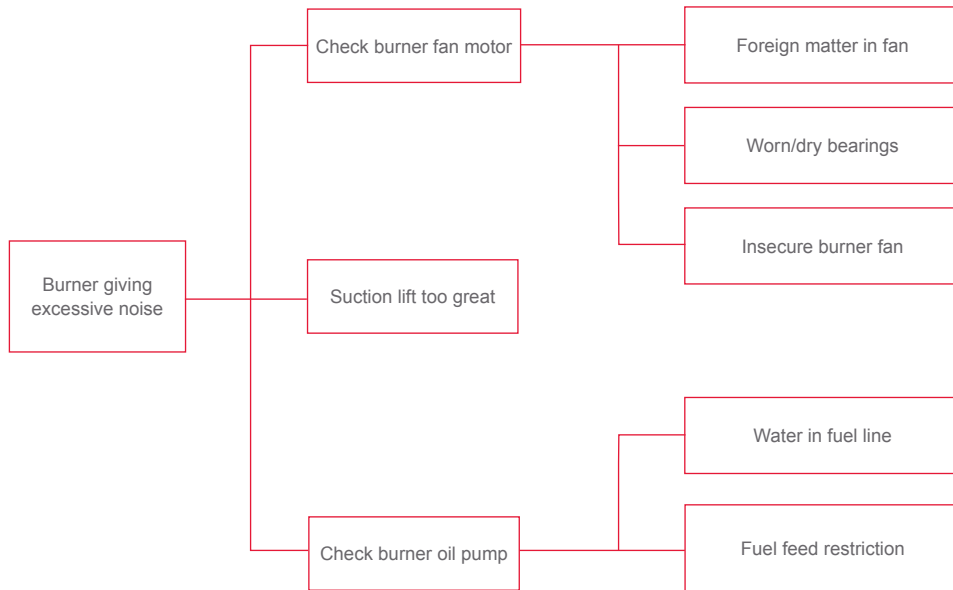

7. Replacement Parts.



It is recommended that only suitably competent persons are allowed to undertake replacement of parts.



7.1 Burner

- Disconnect electrical supply to the heater and shut off oil supply.
- Disconnect fuel line
- Detach electrical connections via plugs.

R40 series:

- Using an 13mm spanner, remove the nut holding the unit to the burner flange.
- Withdraw the burner from the throat of the heat exchanger.

RL34/44 series:

- Using a 6mm Allen key, remove the bolt holding the burner to the flange.
- Pull the burner forward on the two supporting bars.
-  Heavy!
- Remove the two supporting bar bolts and carefully remove the burner through the throat of the flange.
- Replace in reverse order.



7.2 Controller

- Disconnect electrical supply to the heater.
- Remove the burner cover.
- Remove the screw fixing the controller to the base and withdraw controller.
- Replace in reverse order.



7.3 Electrode Assembly

- Disconnect electrical supply to the heater.
- Remove the burner cover.

R40 series:

- Using an 13mm spanner, remove the nut holding the unit to the burner flange.
- Withdraw the burner from the throat of the heat exchanger, support on bracket/flange lugs.
- Remove the fixing screw(s) holding the End Cone and withdraw from burner head.
- Loosen the screw clamping the electrodes.

RL34/44 series:

- Using a 6mm Allen key, remove the bolt holding the burner to the flange.
- Pull the burner forward on the two supporting bars.
- Loosen the screw clamping the electrodes.
- Withdraw electrodes forward and away from the burner.
- Replace in reverse order.

7.4 Nozzle

- Disconnect electrical supply.

R40 series:

- Using an 13mm spanner, remove the nut holding the unit to the burner flange.
- Withdraw the burner from the throat of the heat exchanger.
- Remove the fixing screw(s) holding the End Cone and withdraw from burner head.

RL34/44 series:

- Using a 6mm Allen key, remove the bolt holding the burner to the flange.
- Pull the burner forward on the two supporting bars.
- Heavy!
- Remove the two supporting bar bolts and carefully remove the burner through the throat of the flange and place on flat surface.
- Remove the fixing screw(s) holding the End Cone and withdraw from burner head.
- Remove the fixing screw(s) holding the inner Cone and withdraw from burner head.
- Remove the fixing screw(s) holding the Diffuser Disc Assembly and remove from burner head.
- Using a 17mm spanner, remove the nozzle
- Replace in reverse order.



7.5 Photocell

- Disconnect electrical supply.
- Remove the burner cover.

R40 series:

- Remove the screw fixing the controller to the base and withdraw controller.
- Withdraw photocell from front of controller.

RL34/44 series:

- Remove photocell from side of burner .
- Remove the screw fixing the controller to the base and withdraw controller.
- Remove Photocell cables from controller base.
- Replace in reverse order.



7.6 Oil Pump

- Disconnect electrical supply to the heater and shut off oil supply.
- Disconnect fuel line.
- Disconnect single pipe (or 2 pipe) oil lines from the pump.

R40 series:

- Remove the nut securing the coil and withdraw coil.
- Remove the 3 screws fixing the pump onto the motor shaft.

RL34/44 series:

- Using an 8mm Allen key remove the two pump securing bolts
- Withdraw pump carefully
- Replace in reverse order.



7.7 Contactor/Overload

- Disconnect electrical supply to the heater.
- Remove front panel (below burner)

The contactor and overload are located on the electrical panel plate situated on the right hand side of the unit.



For Overload:

- Disconnect all wiring to the to the overload noting which cables are connected to which terminals
- Loosen the three screws in contactor terminals 2, 4 and 6
- Pull the overload in a downwards movement and unclip from the back of the contactor.
- Replace in reverse order.

For Contactor:

- Disconnect all wiring to the to the contactor and overload noting which cables are connected to which terminals
- Unscrew the two screws fixing the contactor to the electrical panel and remove.
- Loosen the three screws in contactor terminals 2, 4 and 6
- Pull the overload in a downwards movement and unclip from the back of the contactor.
- Replace in reverse order.



7.8 MCB

- Disconnect electrical supply.
- Remove front panel (below burner)

The MCB is located on the electrical panel plate situated on the right hand side of the unit.



- Disconnect the two cables from the MCB noting which cables are connected to which terminals
- The MCB is attached to a DIN rail using a spring loaded din fixing clip - using a small flat head screwdriver, prise the clip downwards to release the MCB.
- Replace in reverse order.

7.9 Fan/Limit Stat Assembly

- Remove the cover plate by removing 4 screws.
- Loosen the cable gland then disconnect the three cables from the fan stat (left hand) and the two cables from the limit stat (right hand) noting which cables are connected to which terminals.
- Remove the two screws fixing the assembly to the body of the heater.
- Carefully withdraw the assembly through the hole and replace in reverse order.



7.10 Fan Belts



The maximum displacement at the mid point of the top edge of the belt must not be greater than 16mm per metre of span, when a force of 3kg is applied in a plane perpendicular to the belt.



- Disconnect electrical supply.
- Remove front lower panel (below burner)
- Loosen fan motor securing bolts on chassis.
- Loosen fan motor slide adjustment bolt.
- Slide fan towards fan to slacken belts.
- Replace belts, pull fan motor away from fan until belts are tight.
- Tighten adjustment bolt to hold motor.
- Tighten fan securing bolts ensuring that the fan is square and the pulleys aligned.
- Check belt tension, making final adjustments as necessary.
- Tighten and clamp fasteners to hold fan motor in position.

7.11 Blower Motor



- Disconnect electrical supply.
- Remove front lower panel (below burner) and side lower panel for ease of access.
- Loosen fan motor securing bolts on chassis.
- Loosen fan motor slide adjustment bolt.
- Slide motor towards fan to slacken belts and remove.
- Remove the four bolts and nuts securing the motor feet to the motor slide and withdraw motor for ease.
- Remove the motor electrical box cover by removing four screws
- Disconnect the electrical cables to the motor connections noting which cables to which terminals.
- Unscrew the cable gland on the side of the electrical box and withdraw the motor cables.
- Replace in reverse order.

7.12 Fan Blower



- The fan blower is removed from the rear of the cabinet heater (opposing side to burner). Ensure there is enough room to work in and to withdraw the fan blower.
- Disconnect electrical supply.
- Remove all lower panels.
- Loosen fan motor securing bolts on chassis.
- Loosen fan motor slide adjustment bolt.
- Slide motor towards fan to slacken belts and remove.
- Remove the two bolts fixing the painted rear lower edge tidy plate from the chassis and remove plate.
- Remove the six screws fixing the rear air deflection shield (three on the right, three on the left) two of which screw into the centre diaphragm plate and two each which screw into the side deflection shields.
- Remove the four bolts fixing the fan feet to the base plate.
- Withdraw the fan blower by sliding it out from the rear.
- Remove pulley assembly
- Replace in reverse order

8. User Instructions

8.1 Commissioning and hand over



As part of the commissioning programme, the commissioning engineer must go through the following with the operator.

- (i) Lighting, shutdown, and operational information.
- (ii) Safety features, data plate, and labelling.
- (iii) The requirement for regular inspection - especially if the heater is within a more demanding environment - and the need for regular servicing, carried out by competent and qualified engineers.



After approximately 100 hours of running, the tension on the fan belts must be checked to ensure that it is correct, and that the belts have not stretched. It is strongly advised that this is undertaken by the commissioning engineer, and not the operator

8.2 Servicing



Servicing must be carried out on a regular basis, the maximum interval between services being one year.

It is a requirement that only suitably qualified and competent persons are allowed to undertake the servicing.

The manufacturers advise that the planned service schedule as detailed in section **4.1 of the Installation, Commissioning and Servicing Manual** is adopted by the user.

Further details are available from either the commissioning engineer or from the Manufacturer (details below)

8.3 Start Up Procedure

- (a) Enable burner via controller by selecting 'Heat' (Relay 2); 'Heat On'; 'Heat/Auto'.*
- (* dependent on control type supplied. Refer to individual controller operating manual.)
- (b) Burner will fire and establish within 60 seconds.
- (c) As temperature of heater increases, fan will operate.

8.4 Stop procedure

- (a) Disable burner by selecting 'Heat OFF'; 'Standby'.*
- (* dependent on control type supplied. Refer to individual controller operating manual.)
- (b) The burner will turn off.
- (c) The fan motor will continue to run until heat dissipation allows the fan and limit stat to shut down the fan.

 Do not use the main electrical isolator to turn off the heater, to do so can cause damage to the heat exchanger and combustion chamber and thereby invalidate the warranty.

8.5 Shut down procedure

- (a) Follow steps 8.4 (a), (b) and (c), when main fan stops turn main electrical isolator off, and shut off oil supply.

8.6 Ventilation only

- (a) Enable fan on via controller by selecting 'Fan only'; 'Vent only'; 'Vent/Manual'.* (*dependent on control type supplied. Refer to individual controller operating manual.)
- (b) Fan will operate without the burner for the set period of the controller.

8.7 Lockout situations

If either the burner or the fan and limit stat go to lockout, the lockout must be cleared manually before the ignition sequence can be re-initiated.

 Repeated or frequent lockouts must be investigated and their cause determined by a qualified and competent engineer.

This manual replaces the previous manual: Part No. 2045-160
Current full Part No. **Reznor Oil Cabinet, EN, May, 18, D301029 Issue B**



NORTEK GLOBAL HVAC (UK) LTD

Fens Pool Avenue, Brierley Hill
West Midlands, DY5 1QA
United Kingdom

Tel: +44 (0) 1384 489 250

Fax: +44 (0) 1384 489 707

reznorsales@nortek.com

AFFIX AGENTS DETAILS HERE