

chaffoteaux ltd.

Chaffoteaux
et Maury 

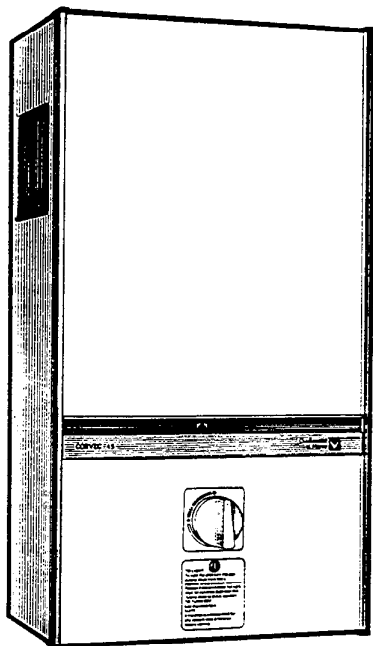

CORVEC 45 OF

OF GC N° 41 980.30

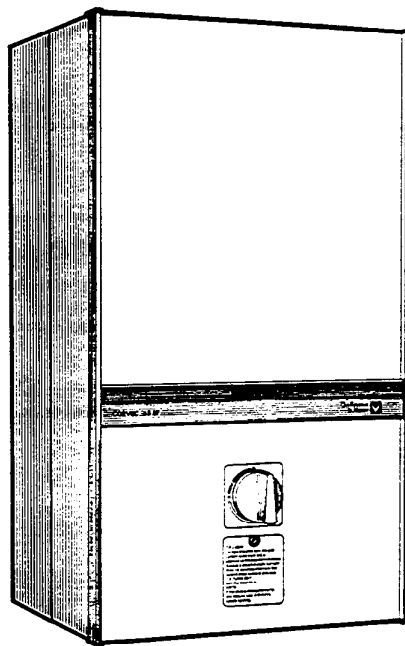

CORVEC 45 BF

BF GC N° 41 980.29

installation

servicing requirements

contents

1) INTRODUCTION

Page 3 : TECHNICAL DATA

Pages 4, 5, 6, 7, 8,
9, 10, 11 and 12 : INSTALLATION

Pages 13 and 14 : SERVICING REQUIREMENTS

Pages 15 and 16 : FAULT FINDING CHART

Page 17 : SHORT LIST

The CORVEC 45 is a wall mounted, low water content boiler available in both balanced flue and open flue versions. The boiler is rated at 13.2 kW, 10.3 kW, or 7.3 kW (45,000 Btu/h, 35,000 Btu/h or 25,000 Btu/h) heat outputs.

The boiler is designed for use with Natural Gas only, unless otherwise stated.

A pump must be installed in the water circulation system irrespective of whether the system is of the open or sealed type.

The CORVEC 45 balanced flue version is supplied in two cartons, one containing the boiler and the other containing the balanced flue set. The CORVEC 45 open flue version is supplied in one carton.

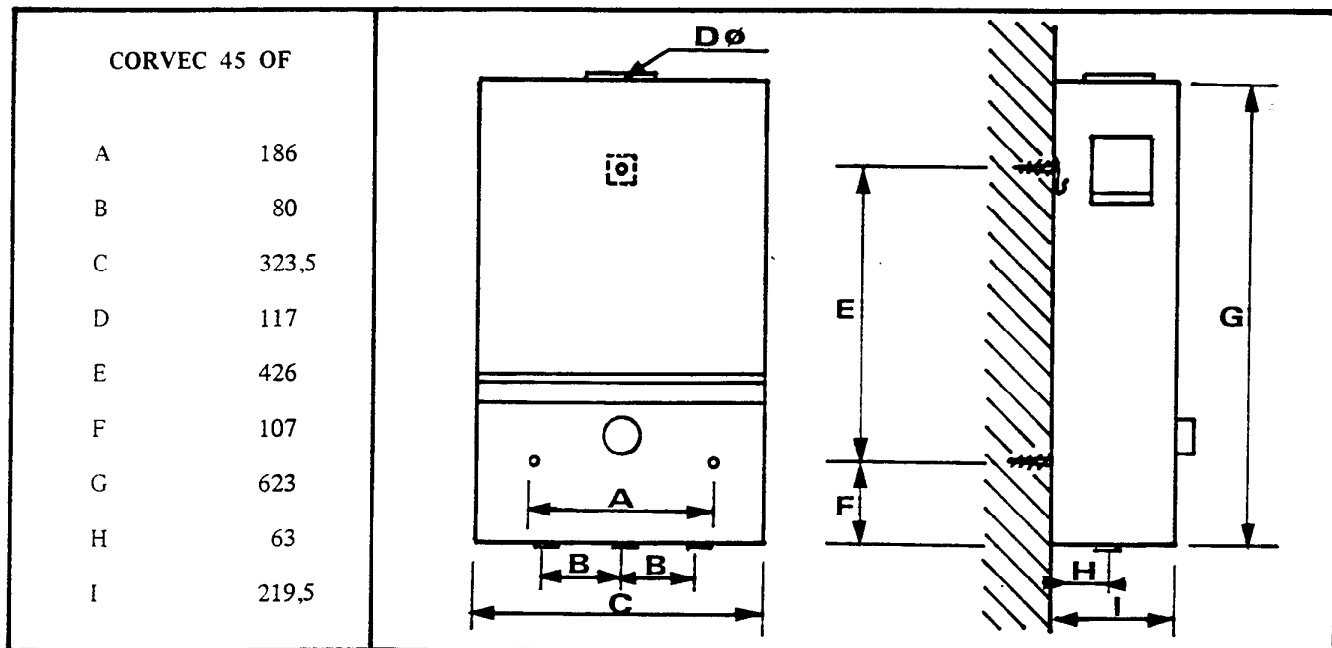
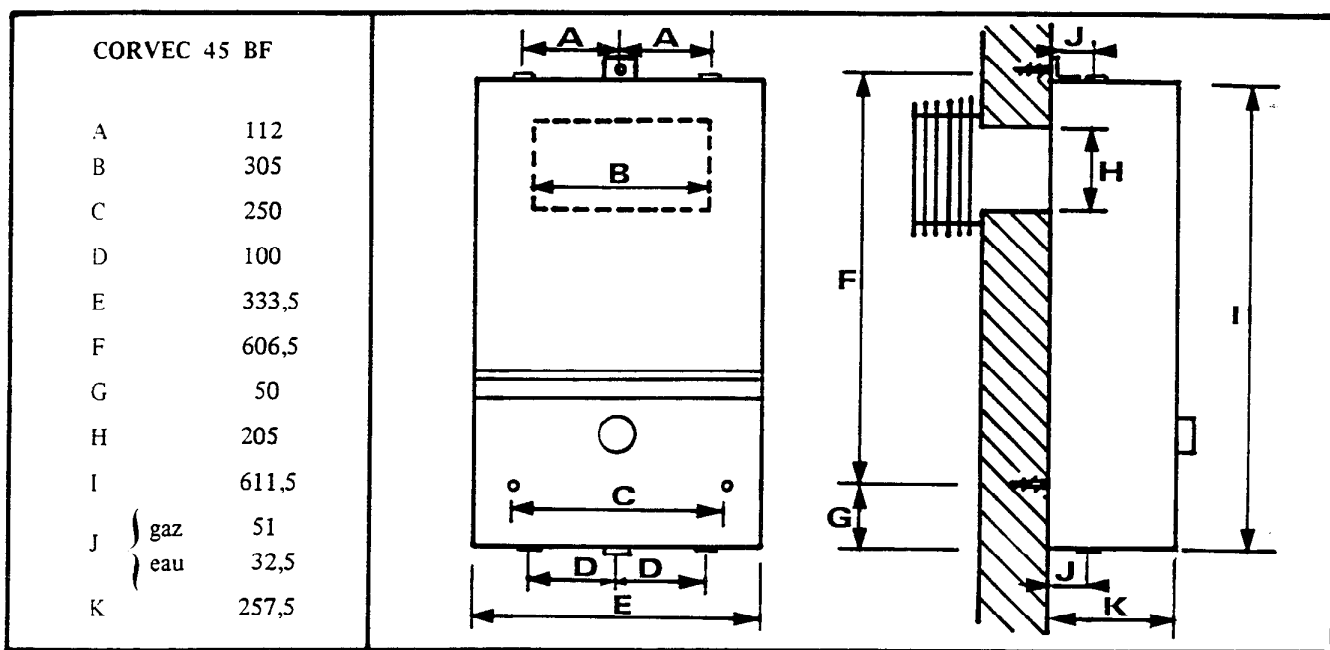

technical data

HEAT OUTPUT		HEAT INPUT		SETTING PRESSURE		RESTRICTOR SIZE
kW	Btu/h	kW	Btu/h	mbar	in w.g.	mm dia
13,2	45,000	17.0	58,000	10.2	4.1	3.7
10.3	35,000	13.4	45,750	6.6	2.6	3.0
7,3	25,000	9.6	32,750	3.5	1.4	2.3

N.B. These boilers are supplied with the 10.3 kW (35,000 Btu/h) output restrictor fitted.

CLEARANCE FOR INSTALLATION AND SERVICING

Balanced flue version :

Sides	25 mm (1 ins)
Top	76 mm (3 ins)
Bottom	127 mm (5 ins)
Front	600 mm (23.6 ins)

Open flue version :

Sides	76 mm (3 ins)
Top	76 mm (3 ins)
Bottom	127 mm (5 ins)
Front	600 mm (23.6 ins)

FLUE CONNECTION

Balanced flue version :

Flue set requires a hole in the wall 205 mm high x 305 mm wide (8 ins x 12 ins).

Open flue version :

Requires a nominal 100 mm (4 in) flue pipe. No split collar is required. Draught diverter is integral.

GAS CONNECTION : 1/2 ins BSP Taper Male (R 1/2)

WATER CONNECTIONS : Flow : 3/4 ins BSP on left hand side of boiler viewed from front.
Return : 3/4 ins BSP

The open flue version has male threads (R 3/4), the balanced flue, female threads (Rc 3/4).

MINIMUM WATER FLOW RATE : 610 L/h (2.24 gal/min).

MINIMUM STATIC HEAD AT BOILER : 300 mm (1.0 ft) See section 5.

MAXIMUM STATIC HEAD AT BOILER : 30 Metres (98 ft).

ELECTRICAL CONNECTIONS : None on the boilers (all control via pump etc...)

DIMENSIONS

Balanced flue version :

612 mm high x 334 mm wide x 255 mm deep
(24 ins x 13.1 ins x 10.0 ins)

Open flue version :

626 mm high x 324 mm wide x 220 mm deep
(24.6 ins x 12.75 ins x 8.7 ins)

WEIGHT : 14.3 kg - 31.5 lbs

WATER CAPACITY : 0.58 litres - 1.02 pints

A 10 blade Chaffoteaux burner is used fitted with 1.13 mm dia injectors. The non-adjustable permanent pilot is manually ignited by a piezo ignitor. The flow temperature is controlled by a non-adjustable thermostat at a nominal 82° C (180° F).

installation

3) INSTALLATION REQUIREMENTS

3.1. General

The installation of the boiler must be in accordance with the Gas Safety Regulations, Building Regulations, I.E.E. Regulations and the Byelaws of the local Water Undertaking. It should be in accordance also with BS Codes of Practice and the British Gas Publication, as specified below, and any relevant requirements of the local Gas Region and Local Authority.

3.2. Location

The position chosen for the boiler should permit the provision of a satisfactory flue termination. The position should also provide adequate space for servicing and air circulation around the boiler.

Where installation will be in an unusual position, special procedures may be necessary, and BS 5376 : 2 gives detailed guidance on this aspect.

A cupboard or compartment used to enclose the boiler must be designed and constructed specifically for this purpose. An existing cupboard or compartment may be used provided that it is modified for the purpose.

Details of essential features of cupboard/compartment design are given in BS 5376 : 2.

3.3. Gas Supply

The gas installation should be in accordance with CP 331 : 3.

The meter to be used must be of adequate capacity to meet the total gas load, i.e. boiler plus other gas appliances.

Ensure that the pipework from the meter to the boiler is of adequate size. Do not use pipes of a smaller size than the boiler gas connection.

The complete installation must be tested for soundness as described in the above Code.

3.4. Flueing

Detailed recommendations for flueing are given in BS 5440 : 1.

The following notes are for general guidance only.

3.4.1. Balanced Flue Version

The boiler must be installed so that the flue terminal discharges directly into the external air.

Termination should be on a clear expanse of wall ; the terminal being preferably not less than 600 mm (2 ft) from a corner, recess or projection.

DO NOT install the terminal :

- Within 300 mm (1 ft), measured vertically, from the bottom of an openable window, air vent or any other ventilation opening.
- Less than 300 mm (1 ft) from ground level.
- Less than 600 mm (2 ft) from any surface facing the terminal.
- Immediately beneath eaves or a balcony.

Where the terminal is less than 2 m (6.6 ft) above the level of any ground, balcony, flat roof or place to which people have access, the terminal must be protected by a guard of suitable material.

Where a terminal guard has not been supplied (optional extra) with the boiler, one may be obtained from Chaffoteaux Limited.

The air inlet/products outlet duct and the terminal of the boiler should be no closer than 50 mm (2 in) to combustible material. Detailed recommendations on protection of combustible material are given in BS 5440 : 1.

3.4.2. Open Flue Version

The boiler should be sited such that the maximum possible length of the flue system can be contained within the building and that the route of the flue rises continuously to the terminal and is as direct as practicable.

Where possible 600 mm (2 ft) of flue pipe should rise vertically from the draught diverter connection before the use of any bends or elbows.

Horizontal or shallow angle runs, right angled bends and mitred elbows should be avoided.

Where an existing brick chimney is to be used, it should be swept thoroughly before connection of the new boiler, and consideration should be given to lining the chimney.

An approved British Gas terminal must be fitted and the terminal sited at the level of the adjacent roof edge, and where possible above the ridge line. The flue must not be terminated at or adjacent to a wall face.

3.5. Air Supply

Detailed recommendations for air supply are given in BS 5440 : 2.

The following notes are intended to give general guidance.

3.5.1. Balanced Flue Version

The room in which a balanced flued boiler is installed does not require a purpose provided air vent.

Where a balanced flued boiler is installed in a cupboard or compartment, air vents are required (for cooling purposes) in the cupboard or compartment at high and low level. These air vents may communicate with a room or direct to outside air.

The minimum effective area requirement of cupboard/compartment air vents are as follows.

Position of air vents	Air from room	Air direct from outside
High Level	210 cm ² (32 in ²)	105 cm ² (16 in ²)
Low Level	210 cm ² (32 in ²)	105 cm ² (16 in ²)

Note - Both air vents must communicate with the same room, or must be on the same wall to outside air.

installation

3.5.2. Open Flue Version

3.5.2.1. Room or Internal Space Air Supply

Where the boiler is to be installed in a room or internal space, the boiler requires the room or internal space containing it to have a permanent air vent. This vent must be either direct to outside air or to an adjacent room or internal space which must itself have a permanent air vent of at least the same size direct to outside air.

The minimum effective area of the permanent air vent (s) is related to the maximum rated input of the boiler and should be 43 cm² (6.6 in²).

3.5.2.2. Cupboard or Compartment Air Supply

Where the boiler is to be installed in a cupboard or compartment permanent air vents are required (for combustion, flue dilution and cooling purposes) in the cupboard or compartment at high and low level. These air vents must either communicate with a room or internal space or be direct to outside air.

The minimum effective areas of the permanent air vents required in the cupboard or compartment are specified below and are related to the maximum rated heat input of the boiler.

POSITION OF AIR VENTS	AIR VENT AREAS	
	Air from room or internal space	Air direct from outside
High Level	150 cm ² 23 in ²	75 cm ² 11.5 in ²
Low Level	300 cm ² 46 in ²	150 cm ² 23 in ²

Note : Both air vents must communicate with the same room or internal space or must both be on the same wall to outside air.

Where cupboard or compartment air vents communicate with a room or internal space, the room or internal space must itself have a permanent air vent (s) as specified in 3.5.2.1.

3.5.3. Effect of an Extract Fan

If there is any type of extract fan fitted in the premises, there is a possibility that if adequate air inlet area from outside is not provided, spillage of the products from the boiler flue could occur when the extract fan is in operation. Where such installations occur, a spillage test as detailed in BS 5440 : 1 must be carried out and any necessary action taken.

3.6. Water Circulation Systems

Open or sealed type central heating systems should be in accordance with the relevant recommendations given in BS 5376 : 2, BS 5449 : 1 (for smallbore or microbore systems) and the British Gas publication entitled "Material and Installation Specifications for Domestic Central Heating and Hot Water".

Hot water systems should be in accordance with the relevant recommendations given in CP 342 : 1 and the above mentioned British Gas publication.

3.7. Electrical Supply

The CORVEC 45 boiler has no electrical connections, but all wiring external to the boiler must be in accordance with the I.E.E. Regulations.

For external wiring instructions, see 4.6. Electrical Connections.

4) INSTALLATION OF BOILER

4.1. General

A vertical flat area is required for the boiler as follows.
Balanced Flue Version - 384 mm wide x 815 mm high (15.1 ins x 32.0 ins).

Open Flue Version - 476 mm wide x 829 mm high (18.75 ins x 32.6 ins).

Above dimensions include the necessary clearances around the boilers for case removal and for air movement.

4.2. Flueing

4.2.1. Balanced Flue Version

The standard flue set supplied with the boiler is suitable for walls having a thickness of 75 mm to 355 mm (3 in to 14 in). (Flue sets for walls of thickness up to 610 mm (24 in) are available to special order).

Using the boiler as a template determine the position for the flue duct. The following procedure should now be followed.

(a) Prepare the Wall

Cut a hole in the wall which measures 205 mm high x 305 mm wide (8 in x 12 in). If the hole is cut accurately, there is no need to line the hole, since the wall liner make a satisfactory seal.

(b) Prepare the Parts

Cut the wall liner to the same length as the wall thickness. Cut the flue duct to the same length, plus 80 mm (3/4 in).

(c) Fit the Wall Liner (fig. 1) (see page 6).

Position the wall liner in place. Ensure that the liner is square and horizontal, and that the flange is flush with the inside face of the wall. With the liner fixed in place, make good the external and internal wall surfaces around the liner with cement.

installation

4.2.2. Open Flue Version

The CORVEC 45 open flue version has a draught diverter outlet suitable for a nominal 100 mm (4 in flue pipe). The flue should be installed in accordance with the requirements of BS 5440 : 1.

4.3. FITTING THE BOILER

4.3.1. Balanced Flue Version

Pull off gas control knob. Remove the screw below the gas control knob and the two screws top and bottom. Remove the front cover by pulling forwards.

On later models the flue bend is produced in the cast aluminium. The Installation Instructions should therefore read, remove the flue bend from the top of the heat exchanger (two screws and clip or clips) and on re-positioning the flue bend replace with the two screws and clip or clips.

Fix the top bracket to the rear boiler case, using the screws provided (fig. 2). Using the boiler as a template, mark all three fixing holes (A fig. 3). Drill and plug the wall.

At this stage the terminal may be fitted from within the building, if required, by passing it through the wall liner before fitting the boiler to the wall. TAKE CARE NOT TO ALLOW THE TERMINAL TO FALL. Attach the chains onto the hooks inside the wall liner (fig. 4). For walls between 3" and 6" thick screw the terminal to the wall face. Attach the self adhesive foam gasket to the flat surface or the boiler around the air inlet spigot on the back of the boiler. Pull off the protective paper whilst sticking down the gasket. Lift the boiler into position with the air inlet spigot locating in the wall liner. Secure the boiler to the wall using the screws and washers provided. If not previously fitted, fit the terminal from the outside. Slide the flue duct through the wall liner and engage it in the terminal by at least 25 mm (1 in) and fully onto the flue bend. The duct may have to be cut to length. Replace the flue bend and secure with the two screws and clips. Ensure that the seal between the heat exchanger and the flue bend is made evenly and securely.

4.3.2. Open Flue Version

The boiler is attached to the wall by a bracket at the top of the boiler and by two screws at the bottom.

Using the dimensions detailed in 2. TECHNICAL DATA, mark the position of the fixing holes for the wall mounting plate ensuring adequate space for connection to the flue pipe.

Remove the boiler cover by pulling off the gas control knob and removing the screw below it. Pull the bottom of the cover forwards then lift off.

Hang the boiler on the wall bracket and mark the positions of the two bottom fixing holes. Drill and plug the wall. Rehang the boiler and screw in position.

Connect the flue to the draught diverter outlet making a good seal between the spigot and flue pipe.

4.4. Gas Connections

The gas service tap must be fitted as in fig. 5. A 15 mm (1/2 in), gas supply must be used from the meter outlet to the boiler.

4.5. Water Connections

The water flow pipe is on the left hand side of the boiler and the water return pipe on the right as indicated in 2. TECHNICAL DATA.

The balanced flue version has a built-in facility for top connection. Where top connection is used, remove the plugs from the two top connections and transfer them to the bottom.

Where bottom outlet connections are used, the blanked off top outlet connections can be used as air vents when commissioning.

The open flue version has no purpose made facility for top connections, but recesses are provided on both sides of the boiler frame to allow pipes to rise within the boiler dimension as shown in 2. TECHNICAL DATA.

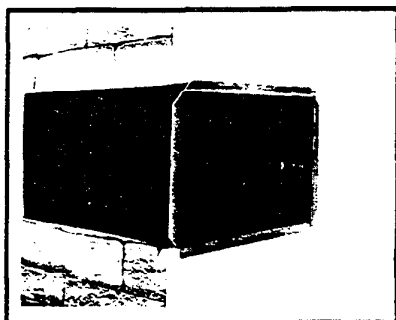

Fig. 1

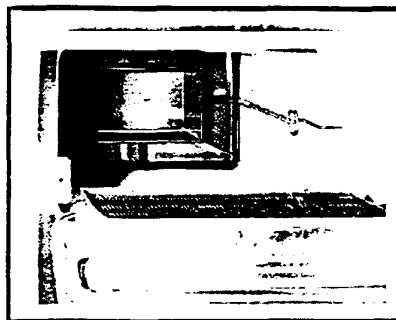

Fig. 4

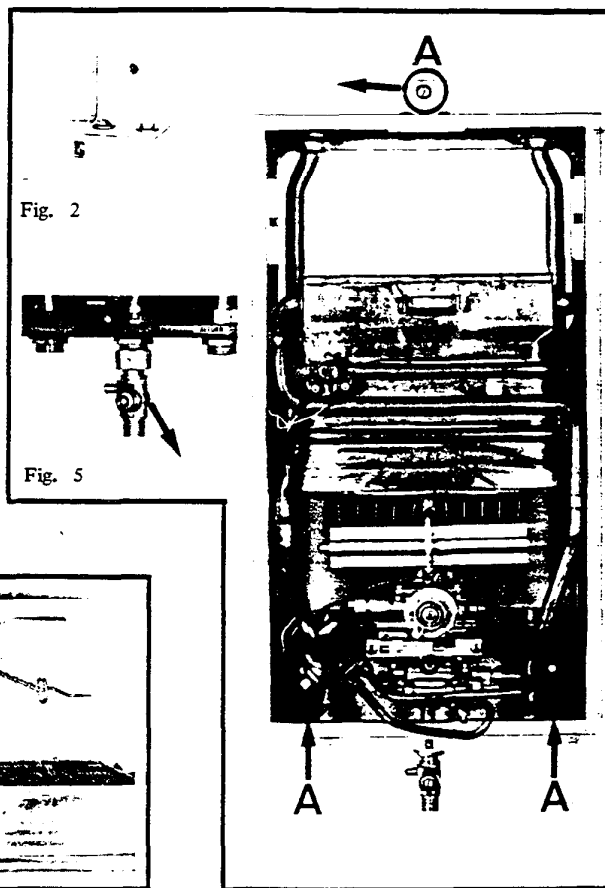

Fig. 3

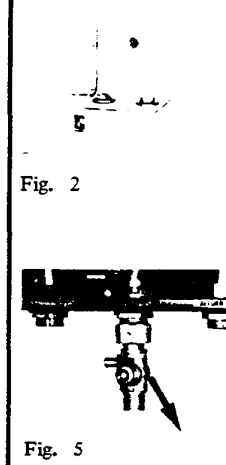

Fig. 2

Fig. 5

installation

4.6. Electrical Connections

The CORVEC 45 has no electrical connections and all external electrical controls should be wired to control the circulating pump.

Most normal pumped primary control schemes can be used, including non-electrical heating and hot water controls.

The following diagrams show typical control schemes using electrical controls only.

fig 6 Hot Water only
Pump, Time Clock and Cylinder Thermostat

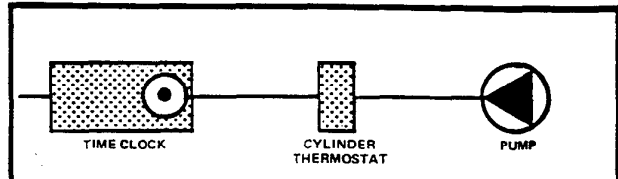

fig 7 Heating only
Pump, Time Clock and Room Thermostat

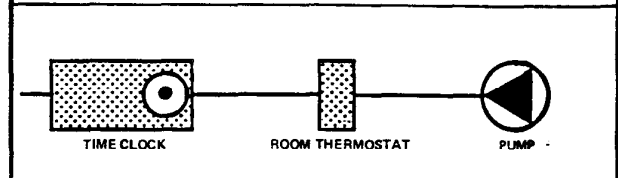

fig 8 Hot Water and Heating
Pump Programmer, Room/Cylinder Thermostat and Flow Share Valve

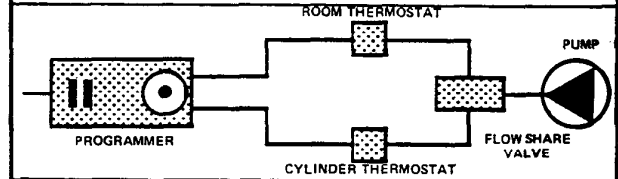
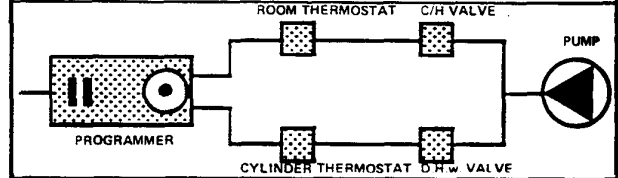

fig 9 Hot Water and Heating
Pump, Programmer, Room/Cylinder thermostats and two Motorized Valves



The following diagrams show typical control schemes using electrical/non-electrical controls.

fig 10 Hot Water and Heating
Pump, Time Clock and Non-Electrical Hot Water and Heating Controls

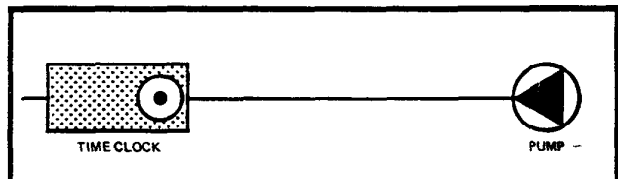

fig 11 Hot Water and Heating
Pump, Time Clock, Non-Electrical Hot Water Control and Electrical Heating Control

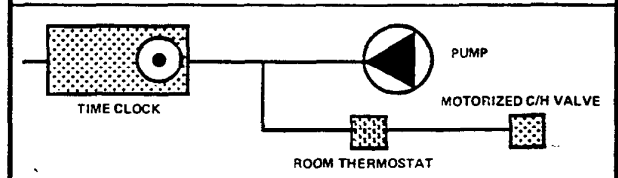
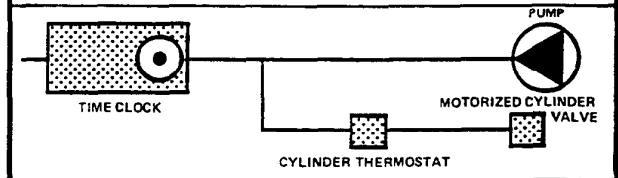

fig 12 Hot Water and Heating
Pump, Time Clock, Non-Electrical Heating Control and Electrical Hot Water Control



It is not normally possible to use full programming facilities when using a mixture of electrical and non-electrical controls, but some non-electrical hot water controls are now available with an external micro-switch which would allow the scheme as in fig. 11 to be fully programmed.

installation

5) WATER CIRCULATING SYSTEM

5.1. General

The CORVEC 45 is a low water content boiler designed **only** for use with fully pumped systems. It may be used with open or sealed systems, all safety controls excluding the pressure relief valve being incorporated in the boiler. The thermostat is set to give a nominal 82° C (180° F) flow temperature and is not adjustable. Thermostatic control must be fitted to the cylinder and heating circuits.

5.2. Control Schemes

The boiler does not incorporate electrical controls or connections, the primary control being provided by the pump, the operation of which will light the boiler, providing that there is a minimum flow of 575 l/h (2.1 gal/m).

Most normal pumped primary control schemes can be used including thermostatic radiator and cylinder valves. When using motorized valves, the system control should be designed to switch off the pump when all circuits are satisfied.

For details of wiring and of control schemes, see 4.6. Chaffoteaux Limited should be consulted where technical assistance is required.

5.3. Isolating Valves

Two isolating valves should be fitted adjacent to the boiler to allow full servicing facilities. Where the circulating pump is adjacent to the boiler and is provided with isolating valves, it is only necessary to fit one isolating valve in the boiler flow. Fig. 13 shows a typical pipework arrangement.

5.4. Circulating Pump

The circulating pump should be fitted in the return as shown in fig. 13, and should be sized to overcome the hydraulic resistance of the boiler and system. The boiler requires a minimum flow rate of 610 l/h (2.24 gal/min) for its correct operation and at this flow has a resistance of 2.9 metres (9.5 ft). See graph.

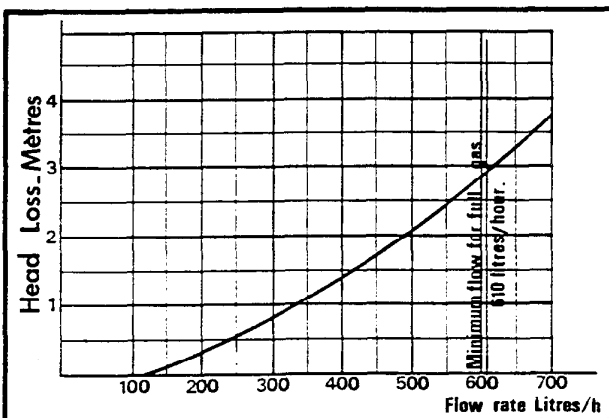

Where it is impossible to fit the pump in the return. It may be fitted in the flow as shown in fig 14, providing that there is a minimum of 3.2 metres (10.5 ft) static head between the water level in the feed and expansion tank and the top of the boiler casing.

5.5. System By-Pass

A valved system by-pass as shown in figs 13 and 14 may be required to ensure adequate water flow through the boiler. The by-pass should be a 15 mm (1/2 in) pipe with a suitable balancing valve.

5.6. Automatic Air Separators

Chaffoteaux Limited strongly recommend the inclusion of a British Gas accepted automatic air separator in the system as shown in fig 13 and 14.

Where an air separator is not fitted, the open vent pipe should rise continuously from the pump inlet and the common return be introduced at right angles to this pipe. The preferred arrangement is shown in fig 15.

5.7. Open Systems Only

5.7.1. Cylinder

The domestic hot water cylinder used with the CORVEC 45 must be of the indirect coil and high recovery type. Flow and return pipework to the cylinder should be in 22 mm (3/4 in) pipe.

5.7.2. Feed and Expansion Tank

The feed and expansion tank should be connected as shown in figs 13 or 14 and should not be mounted closer than 9 ins to a ceiling to allow access to the ball valve.

The minimum static head for the CORVEC 45 should be 300 mm (1.0 ft) for the pump on the return (fig. 13) and 3.2 metres (10.5 ft) for the pump on the flow (fig. 14).

5.8. Sealed Systems Only

5.8.1. Safety Valve

A safety valve shall be fitted close to the appliance on the flow pipe by a horizontal or a vertically upward connection. Only safety valves set to operate at 3 bar shall be used; they shall be so positioned, or any discharge pipe so arranged, that discharge of water or steam from the valve cannot create a hazard to occupants of the premises or cause damage to electrical components and wiring.

5.8.2. Pressure Gauge

A pressure gauge covering at least the range 0.4 bar (0.60 lb/in²) shall be fitted to the system adjacent to, and visible from, the filling point.

installation

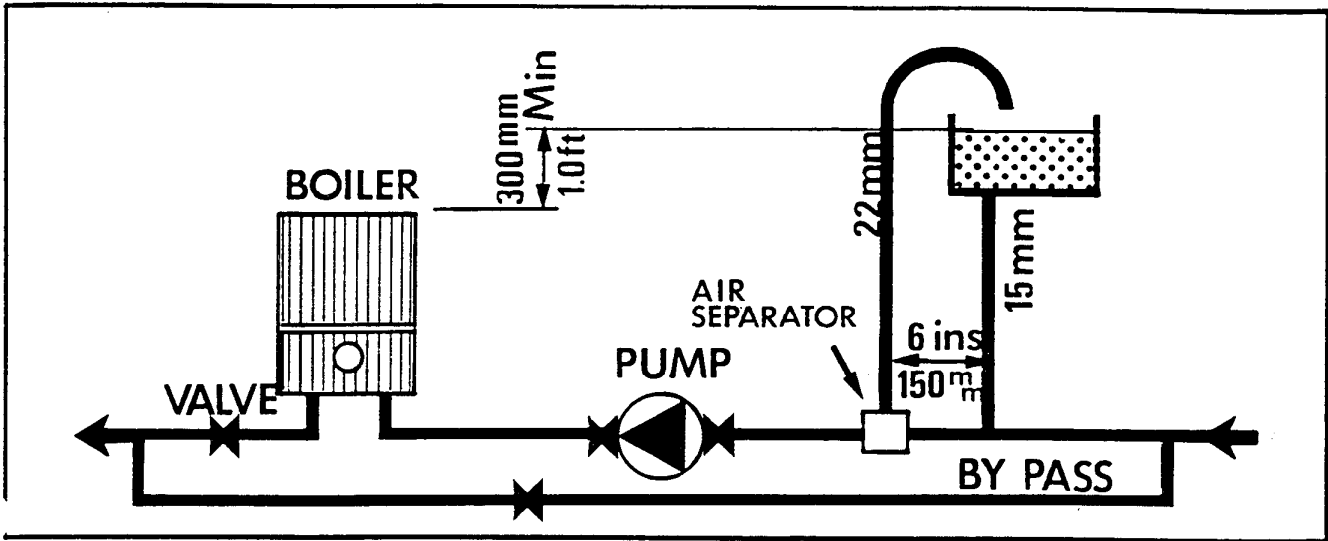

Fig. 13

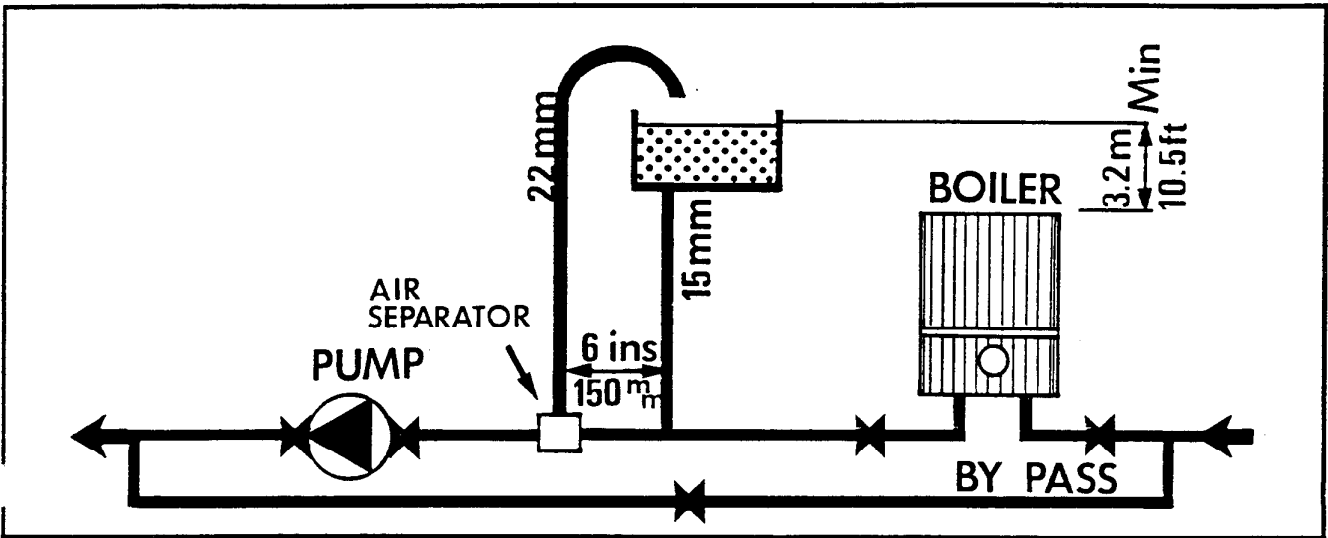

Fig. 14

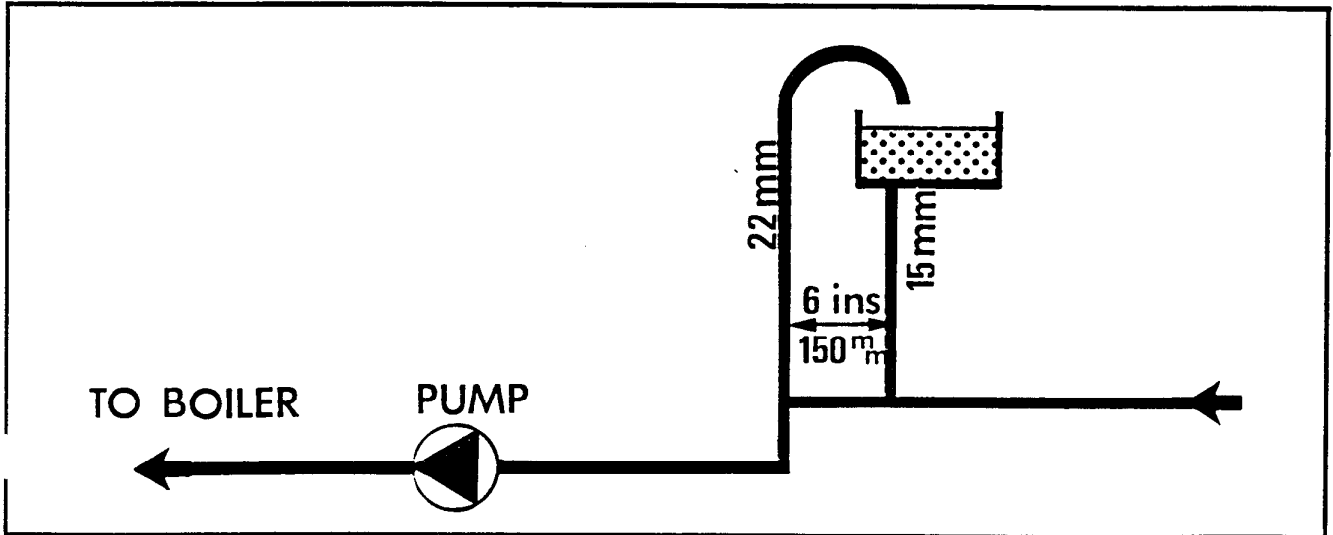

Fig. 15

installation

5.8.3. Expansion Vessel

- (i) A diaphragm type expansion vessel shall be fitted by a connection to the inlet side of the circulating pump, in a manner laid down in the vessel maker's instructions (see fig 16 for illustration of recommended system layouts). The expansion vessel shall be capable of accepting water up to at least 62.5 % of its volume without damage.
- (ii) The nitrogen or air charge pressure of the expansion vessel shall be not less than the hydro-static head (height of the top point of the system above the expansion vessel).
- (iii) The expansion vessel shall be sized in accordance with the following Table.

Air or nitrogen charge pressure (bar*, gauge)		Expansion Vessel Volume (litres)			
		0,5		1,0	
Pre-pressurisation pressure (bar*, gauge)		None	1,0	None	1,5
System Volume					
Litres	Gallons				
20	4.4	1.4	2.4	1.8	3.3
40	8.8	2.8	4.9	3.7	6.6
60	13.2	4.2	7.3	5.4	9.8
80	17.6	5.6	9.8	7.3	12.3
100	22.0	7.0	12.2	9.1	16.4
120	26.4	8.4	14.6	11.0	19.7
140	30.8	9.8	17.0	12.8	23.0
160	35.2	11.2	19.4	14.6	26.2
180	39.6	12.6	21.9	16.4	29.5
200	44.0	14.0	24.3	18.2	32.8

* 1 bar 14.5 lb. f/in² (Approx. 1 atmosphere or 34 feet head of water).

Where a vessel of the calculated size is not obtainable, the next available larger size should be used.

For the purpose of the above calculation, the volume of the system shall be determined as accurately as possible using manufacturers' data as appropriate. Alternatively the volumes given below may be used to give a conservative estimate of the system volume :

Low water capacity boiler	0,8 litres (0.18 gallons)
Small bore pipework	0.3 litres (0.07 gallons) per 0.292 kW (1000 Btu/h) of system output.
Microbore pipework	7 litres (1.5 gallons)
Steel panel radiators	2.3 litres (0.5 gallons) per 0.292 kW (1000 Btu/h) of system output.
Hot water cylinder	2 litres (0.44 gallons)

If a system is extended, an expansion of increased volume may be required unless previous provision has been made for the extension.

installation

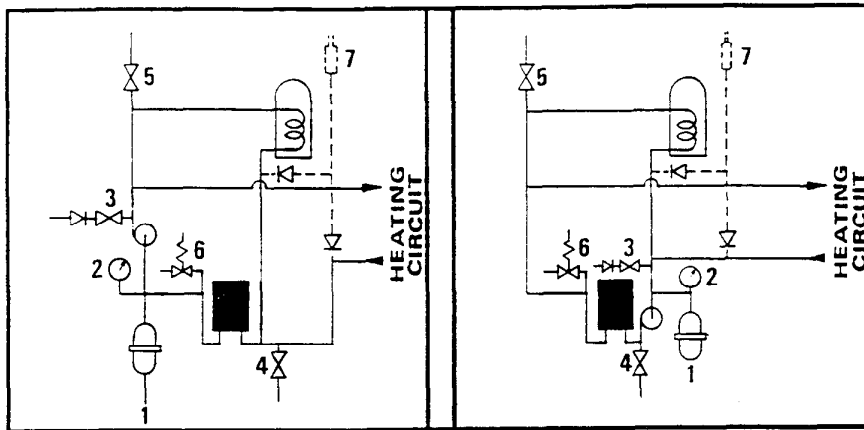

PUMP ON THE FLOW

Fig. 16

PUMP ON THE RETURN

DIAGRAMS SHOWING SYSTEM LAYOUT

- 1 - Expansion vessel
- 2 - Pressure gauge
- 3 - Filling point
- 4 - Drain cock
- 5 - Air release point
- 6 - Safety valve
- 7 - Top-up bottle

5.8.4. Hot Water Storage Cylinder

The hot water cylinder shall be the indirect coil type which is suitable for the system pressure.

5.8.5. Make-Up System

Provision shall be made for replacing water lost from the system either :

- (i) From a make-up vessel or tank mounted in a position higher than the top point of the system, and connected through a non-return valve to the system on the return side of the hot water cylinder or the return side of all heat emitters, or.
- (ii) Where access to a make-up vessel would be difficult, by pressurisation of the system.

5.8.6. Mains Connection

There shall be no connection to the mains water supply or to the water storage tank supplying domestic water, even through a non-return valve, without the approval of the local Water Authority.

5.8.7. Filling Point

The system shall be fitted with a filling point at low level, which shall have a stop valve to BS 1010, a test cock, an anti-vacuum valve and a non-return valve approved by the National Water Council in this order from the system to the mains.

5.8.8. Pipework

Pipework should be of copper ; small bore or microbore with capillary or compression jointing to a high standard. Leak sealant shall not be used in the system.

8.9. Feed and Expansion System

Except as provided for above, the expansion cistern and cold feed required for open systems shall not be fitted to sealed systems.

5.9. Inhibitors

Chaffoteaux Limited do not generally recommend the inclusion of an inhibitor with heating and hot water systems, utilizing the CORVEC 45 boilers. It is, however, appreciated that the specification for a new installation may require the addition of an inhibitor and the following are the appliance manufacturers recommendations.

- (i) Use only a British Gas approved inhibitor.
- (ii) Use only the quantities specified by the inhibitor manufacturer.
- (iii) Add the inhibitor only when the system has all air removed.

6) COMMISSIONING AND TESTING

6.1. Electrical Installation

Checks to ensure electrical safety should be carried out by a competent person.

6.2. Gas Installation

The whole of the gas installation, including the meter, should be inspected and tested for soundness and purged in accordance with the recommendations of CP 331 : 3.

6.3. Water Circulation System

6.3.1. Open System Only

The whole of the system should be fitted and thoroughly flushed out with cold water without the pump in position. Ensure that all valves are open.

With the pump fitted, the system should be filled and air locks cleared. The boiler water section can be vented if necessary by unscrewing the knurled nut on the drain valve (see 6.6.) and the top outlet plugs (see 4.5.). Vent all radiators and check for water soundness.

Light the boiler as detailed in 6.4.

The water system should be heated to maximum working temperature and examined for water soundness. Both gas and water should then be turned off and the water system rapidly drained while still hot.

installation

The system should again be filled, cleared of air locks and examined for water soundness.

Add inhibitor to the system if required in the specification (see 5.9.)

6.3.2. Sealed System Only

The whole of the system should be filled and thoroughly flushed out with cold water without the circulating pump in position. Ensure that all valves are open. (The system must be filled with water either from a sealed system filler pump with a break tank, or by any other method approved by the local Water Undertaking).

With the circulating pump fitted, the system should be filled and air locks cleared until the pressure gauge registers 1.5 bar (21.5 lbf/in²). (The boiler water section can be vented if necessary by unscrewing the knurled nut on the drain valve, see 6.6). Vent all radiators and check for water soundness.

Manually raise the water pressure to ensure that the safety valve lifts. This should occur within ± 0.3 bar (± 4.3 lbf/in²) of the preset lift pressure, i.e. 3 bar (43.5 lbf/in²).

Release water from the system until the initial system design pressure is attained, taking into account any difference in height between the pressure gauge and the point at which the pressure vessel is connected.

Light the boiler as detailed in 6.4.

The water system should be heated to maximum working temperature and examined for water soundness. Both gas and water should then be turned off and the water system rapidly drained whilst still hot.

The system should again be filled, cleared of air locks and adjusted to the initial system design pressure. Any set pointer on the pressure gauge should be set to coincide with the indicating pointer. Examine for water soundness.

Add inhibitor to the system if required in the specification (see 5.9.).

6.4. Lighting the Boiler

The following procedure should be followed :

- (a) Check that the gas service tap is open.
- (b) Replace the gas control knob.
- (c) Turn the gas control knob in an anticlockwise direction which will automatically light the pilot.

N.B. It may be necessary to wait a few moments for gas to reach the pilot.

- (d) Wait 15 seconds, then turn the gas control knob slowly, fully, in an anticlockwise direction. If pilot is extinguished for any reason, wait 3 minutes before lighting.
- (e) The boiler is now ready to operate and will light when water is pumped through.
- (f) Test for gas soundness using sense of smell and leak detection fluid.
- (g) Check and, if necessary, adjust the gas rate as detailed in 6.5.

6.5. Gas Rate Adjustment

The boiler is not fitted with a governor.

To obtain the required output, it may be necessary to change the restrictor situated in the burner manifold (fig. 17). To alter the heat output remove the pilot supply tube and the two screws securing the burner manifold to the burner assembly. Replace the restrictor with the required size as detailed in TECHNICAL DATA. Replace the burner manifold and pilot tube.

Since the opening of the gas valve depends upon water flow rate, make the above adjustment when all the air is removed from the system and all radiator valves are fully open.

Mark the data badge in the line "SET TO" (against output) to which the boiler has been adjusted. The data badge is situated inside the case.

6.6. Balancing the System By-Pass

The system by-pass should be balanced as the final part of commissioning.

1. A system by-Pass is not required for the safe operation of the boiler, which will automatically shut down if the flow rate drops below 500 l/h (1.85 gpm). If however the system may be required to be used with a large reduction of heat output at certain times i. e. a reduced number of radiators, then a 15 mm system by-pass should be used. This should be fitted as shown in diagram 6. To set the system by-pass, close the by-pass valve and turn off the required number of radiators to suit the customer's needs then open the by-pass until the boiler lights.
2. Check system on hot water only. Open by-pass further if necessary to obtain correct operation.

6.7. Draining the Boiler

Close the valves in the pipework connecting the boiler to the system (fig. 13 or 14). Drain the boiler unscrewing the knurled nut on the drain valve.

7) BOILER CASE ASSEMBLY

7.1. Balanced Flue Version

Fit front cover and refit securing screws at the top and bottom and immediately under the gas control.

Push on gas control knob.

7.2. Open Flue Version

Fit case and refit securing screw immediately under the gas control. Push on gas control knob.

Hand the USER'S INSTRUCTIONS to the user for retention and instruct in the operation of the boiler.

Advise the user of the precautions necessary to prevent damage to the system and to the building in the event of the system remaining inoperative during frost conditions.

Finally advise the user that, for continued efficient and safe operation of the boiler, it is important that adequate servicing is carried out at regular intervals recommended by the local Gas Region.

servicing requirements

9) SERVICING REQUIREMENTS

For efficient and trouble free operation it is important that the CORVEC 45 receives regular maintenance. The following schedules are recommended.

Before commencing any work, turn off the gas at the gas inlet tap and isolate the boiler from the water circulating system (see 5.3.). Ensure that the electricity supply to the system is switched off. Remove the front cover as detailed in 4.3.1. or 4.3.2.

9.1. Annual Service

9.1.1. Clean the Burner (fig. 17).

Unscrew the pilot tube clamping screw A. and remove the clamp and tube. Remove the burner manifold by unscrewing fixing screws B. Pull burner head assembly forward to remove, taking care not to trap the thermocouple or ignitor wires. Invert the burner head and clean by brushing. Replace in reverse order ensuring that the burner head is correctly located on the spigot at the rear, and that the gasket between the burner manifold and gas section is in place.

9.1.2. Clean the Heating Body

Remove the flue bend on balanced flue versions as detailed in 4.3.1.

Drain the boiler as detailed in 6.7.

Remove burner as detailed in 9.1.1.

Remove the two wires from the fusible link overhear carrier taking care not to lose the nuts and washers.

B.F. Model - Remove the screw holding the bottom of the heating body skirt of the rear case.

O.F. Model - Slacken the four screws holding the clamping plate of the heating body to the rear case. Remove the screw fixing the top of the heating body to the draught diverter.

Release the two union nuts joining the heating body legs to the water section.

Remove the heating body.

Clean the heating body by brushing with hot water and detergent. Do not attempt to clean the internal waterways of the heating body without prior consultation with the manufacturer. Before replacing heating body, see 9.1.3. Replace in reverse order, using new washers where applicable.

9.1.3. Clean the Pilot Assembly, Thermocouple and Spark Electrode

Unscrew the pilot tube clamping screw and remove the clamp and tube. Blow through the tube to remove any dust. Remove the burner as in 9.1.1.

Unscrew the knurled outer ring of the pilot burner (B - fig. 18).

Unscrew the pilot body (C - fig 18) with a 15 mm spanner. It may be necessary to remove the heating body (9.1.2.) if this has already been replaced.

Clean the pilot body by blowing or washing. Do not clean the holes with a wire.

Disconnect the thermocouple from the overheat terminal stud. With a 7 mm box spanner, unscrew the nut holding the thermocouple into the gas section (D fig. 19). Thread the thermocouple and wire up through the gas section.

Clean the end of the thermocouple by brushing.

Remove the spark electrode fixing screw (E - fig 19) with a cruciform head screwdriver.

Pull off the electrode cable from the piezo ignitor.

Lift the electrode out of the gas section. Clean the end of the electrode by brushing. Blow any dust out of the gas section.

Replace all parts in reverse and ensure that the slot in the electrode cable connector is vertical when pushed onto the piezo ignitor. The pilot flame is non-adjustable. When burning correctly, the flame should be 3/16" to 1/4" high, reaching half way up the exposed part of the thermocouple.

9.1.4. Clean the Gas Filter

Unscrew the union nut attaching the gas inlet tap to the appliance. Lower the union nut and withdraw the filter which also acts as a washer. Clean the filter by blowing or washing in water. Do not use any solvents. Replace in reverse order.

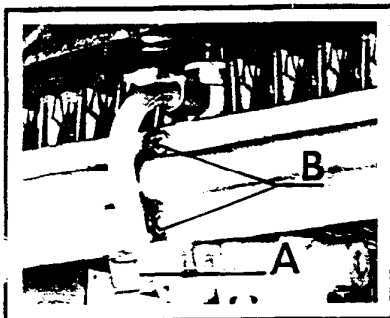

Fig. 17

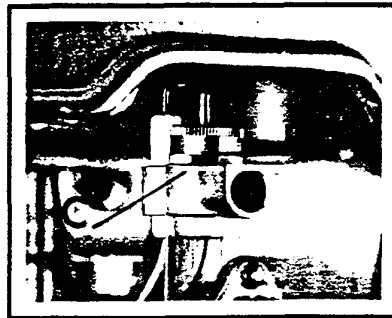

Fig. 18

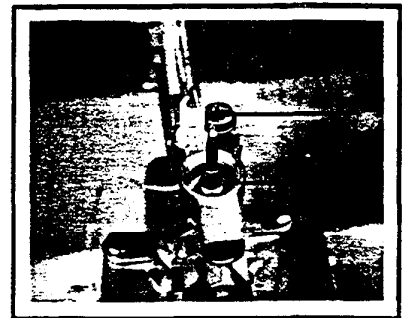

Fig. 19

servicing requirements

9.1.5. Clean the Thermostat Capsule

Drain the boiler as detailed in 6.7.

Using a 14 mm spanner, remove the thermostat housing cover taking care not to loose the spring. Remove the thermostat capsule and clean with soap and water. Replace in reverse order.

9.1.6. Clean the water filter

Drain the boiler as detailed in 6.7. The water filter is situated in the inlet to the venturi. Unscrew the union nut on the flow pipe from the heating body at the venturi (fig. 20). Remove the filter, clean in water and replace.

9.2. Three Yearly Service

9.2.1. Clean Burner, Heating Body, Pilot Assembly and Thermocouple.

As detailed in 9.1.1. - 9.1.3.

9.2.2. Replace the Gas Filter

As detailed in 9.1.4.

9.2.3. Replace the Diaphragm

Drain the boiler as detailed in 6.7.

Unscrew the four water union nuts (A - fig. 21) on the water section.

Unscrew the six screws (B - fig 21) holding the water section to the gas section. Note the relative positions of the gas and water sections and the two halves of the water section. Unscrew the two screws holding the water section clamp.

Remove the water section complete with the diaphragm and bearing plate. Separate the top and bottom halves of the water section by removing the eight screws.

Remove diaphragm and discard. Wash out water section.

Replace with a new diaphragm fitted and the bearing plate positioned on the top of the diaphragm.

Reassemble with the components in their original relative positions.

9.2.4. Clean the Gas Valve

Remove the burner as in 9.1.1.

Disconnect the thermocouple from the overheat terminal stud and pull off the electrode cable from the piezo ignitor.

Remove the four fixing screws fastening the top of the gas section to the base. Also the two screws at the back holding it to the rear case.

Lift the gas section top off the base.

Remove the gas valve spring.

Lift out the gas valve.

Do not attempt to further dismantle the valve assembly.

Clean the valve seating and replace the gas valve facing rubber if necessary.

Replace in reverse order.

10.1 To replace the Thermo-electric Valve

Remove the thermocouple nut.

Unscrew cap from the side of the gas section and withdraw the thermo-electric valve. Replace if necessary.

10.2 To replace the Fusible Link

Remove the two nuts securing the thermocouple leads to terminals of the overheat assembly.

Remove clamping disc.

Remove fusible link.

Replace the fusible link. When forming the wires to shape, avoid bending them close to their entry into the fuse.

Use long nosed pliers to support the wire.

Re-assemble in reverse order.

10.3. To replace the Piezo Ignitor Cartridge

Pull off the electrode lead from the cartridge.

Remove the screw holding the gas control cam.

Pull the cam off the spindle.

Remove the two screws holding the retaining plate in position.

Remove the plate and then the Piezo cartridge.

Replace in reverse order, note the slot in the end of the electrode cable is vertical when pushed on to the Piezo.

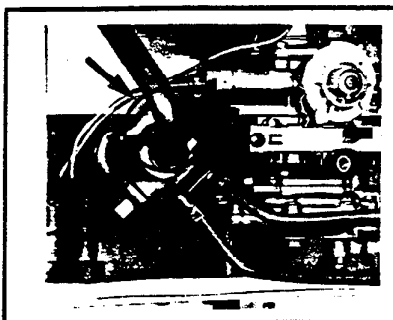

Fig. 20

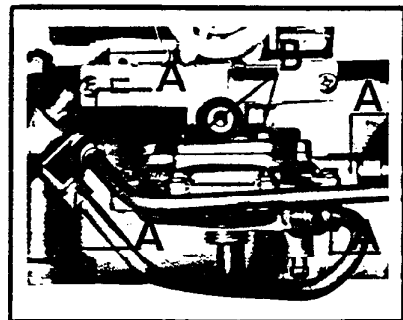

Fig. 21

fault finding chart

FAULT	POSSIBLE CAUSE	REMEDY
Pilot will not light	Gas supply not turned on. Gas supply pipes not purged of air. Fusible Link open circuited. Fusible Link shorting to earth.	Turn on. Purge. Replace. Re-position.
Pilot lights with taper but not with igniter	Spark electrode wrongly positioned. Spark from electrode not jumping to thermocouple. Electrode lead detached from Piezo Ignitor. Electrode lead damaged causing local short circuit. Faulty Piezo Ignitor.	Re-position. Refit. Replace. Replace.
Pilot goes out	Pilot too small, injector blocked. Thermocouple/thermo-electric valve faulty, low MV output. Thermocouple loose. Terminal wrongly positioned causing re-circulation. Flue set wrongly fitted causing re-circulation. Fusible Link fused. Fusible link earthing out. Securing nuts loose. Insulation washers fitted incorrectly. Low meter pressure. Pilot flame too soft.	Replace or wash in solvent. Replace. Tighten. Installer to resite boiler. Fit correctly. Replace. Refit. Re-tighten. Refit. Gas Region to adjust. Clean pilot tube or replace pilot injector.
Main burner "lifts"	Re-circulation of flue products. Terminal badly sited and flue set wrongly assembled. Terminal not fitted in wall-liner. Over-gassed. Check sealing of flue.	Remove flue set and fit correctly. Refit. Fit correctly. Adjust, set to correct gas rate. Re-seal and fit correctly.

fault finding chart

FAULT	POSSIBLE CAUSE	REMEDY
<p>Main burner will not light or lights at low rate</p>	<p>Low flow rate pump duty not sufficient.</p> <p>Low flow rate system very restrictive. Low flow rate, air in system.</p> <p>Water section spindle bent or dry Diaphragm split or stretched. Thermostat not seating properly. Gas supply insufficient.</p> <p>Heat exchanger blocked Pump speed too slow. Flow and return pipes crossed or plaster, cement in pipes.</p>	<p>Fit a suitable pump.</p> <p>Open system by-pass. Purge thoroughly, fit air separator if air is persistent or where convectors are used as heat emitters.</p> <p>Replace or grease. Replace. Inspect, clean. Check working pressure 8 ins. wg at service tap. Descale or replace. Adjust.</p> <p>Rectify.</p>
<p>Complaints of noise</p>	<p>Over-gassed Sludge/scale in the heat exchanger. Faulty boiler thermostat. Water section push rod sticking. Gas valve sticking open. Dirt/swarf on gas valve facing. Resistance to water flow. Water filter blocked. Venturi blocked. Wrongly positioned feed and vent.</p> <p>Incorrect inhibitor in system.</p> <p>Pump noisy or vibrating.</p>	<p>Check rate, adjust. Wash/descale or replace. Check flow temperature. Clean. Clean gas valve spindle. Reassemble. Open restrictive valves. Clean. Clear venturi. Re-position on suction side of pump. Inhibitor not recommended - contact Chaffoteaux Limited. Replace or refit.</p>

Notes

Notes

Notes

CHAFFOTEAUX LIMITED
Concord House - Brighton Road
Salfords - Redhill
SURREY RH1 5 DX
HORLEY (02934) 72744

teaux et Maury
J.112 - 9/82

Imp
Rsf.

ESP020